

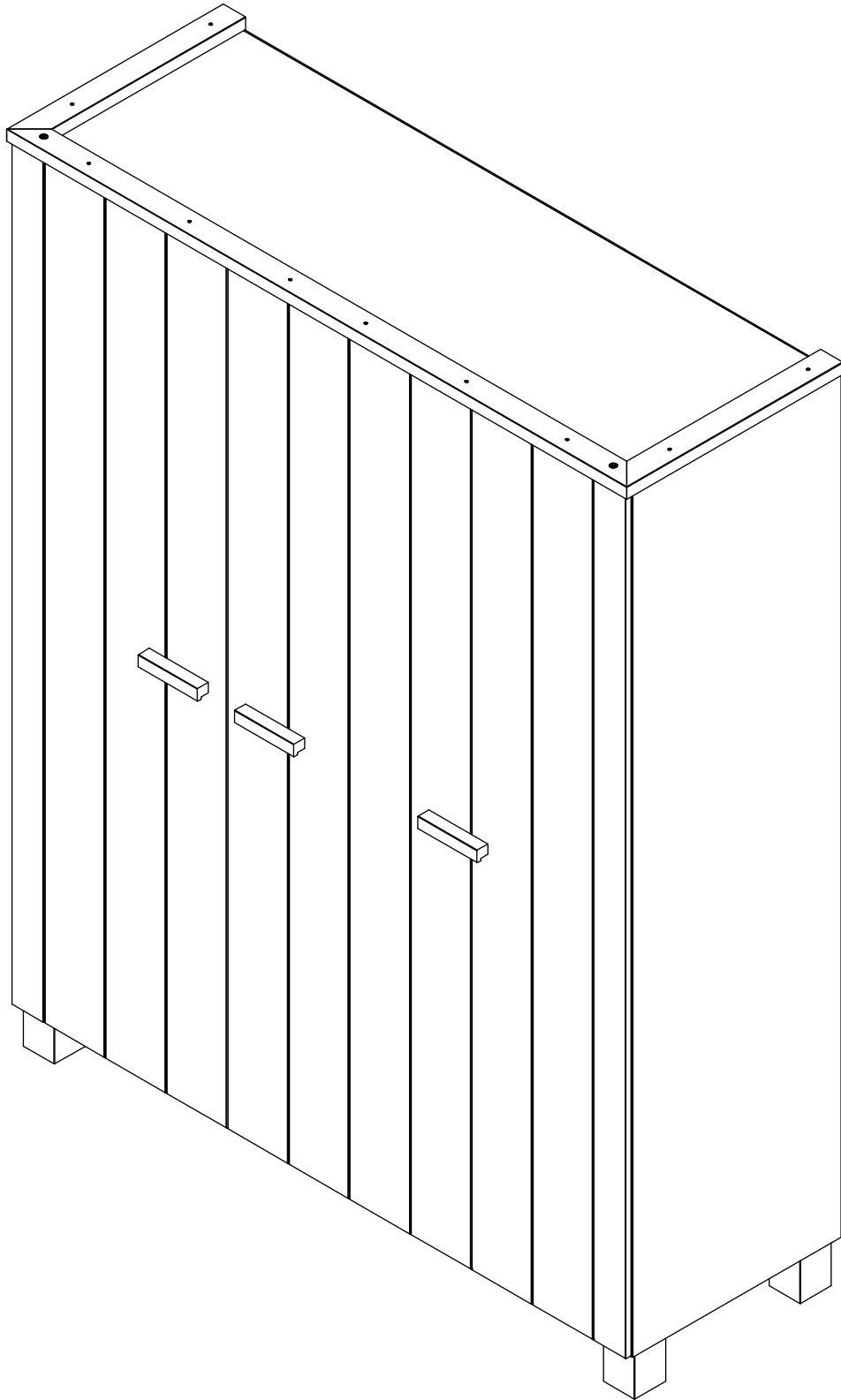

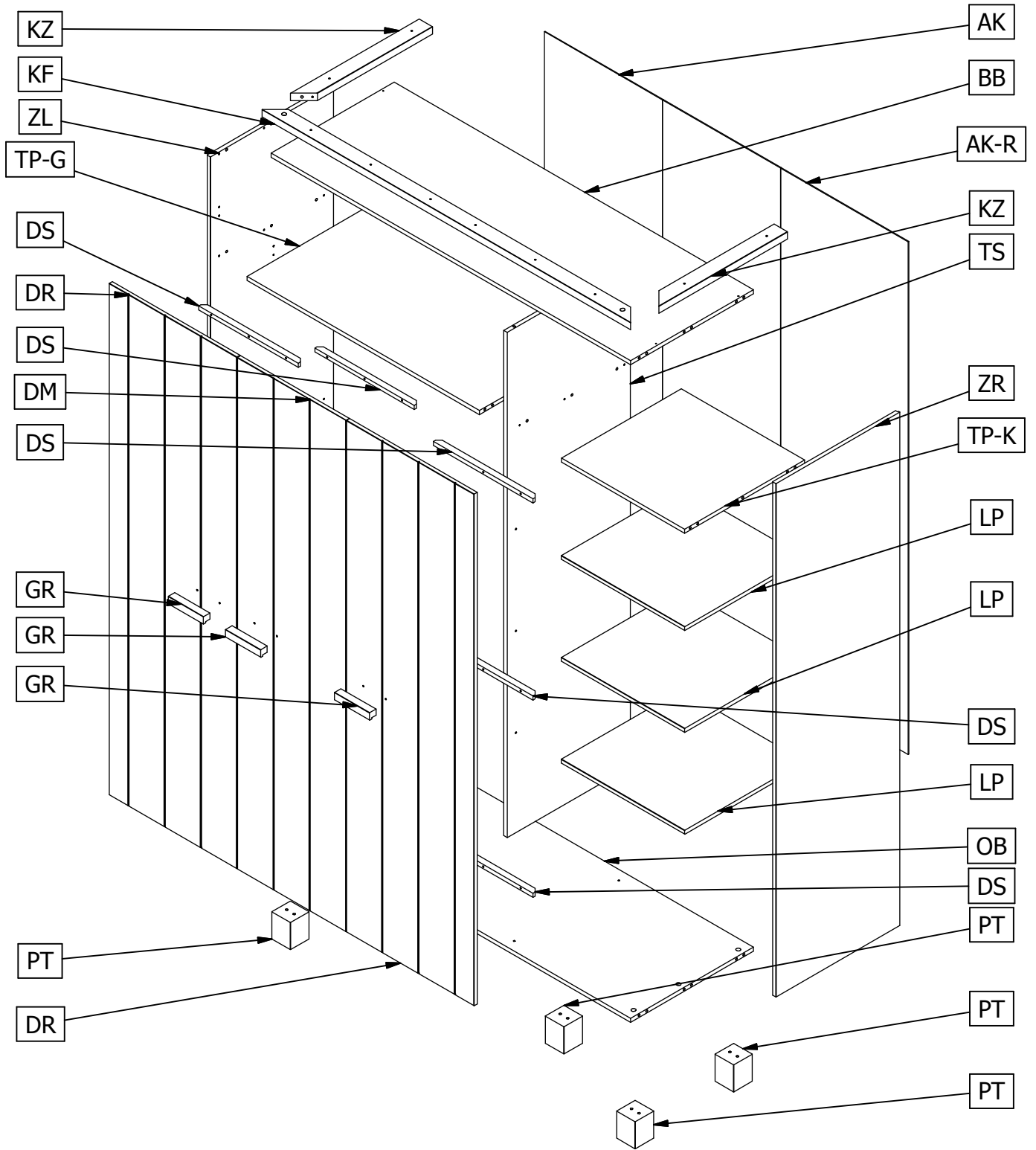







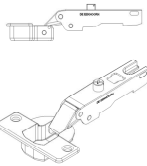
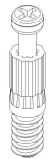
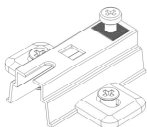

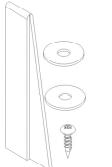

# DENNIS 3-DEURS KAST

3-TÜRIG SCHRANK - ARMOIRE 3 PORTES - 3-DOORS WARDROBE



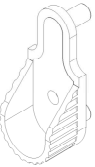
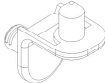

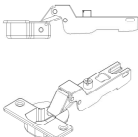
30	Ø15mm	AC000102 	6	Ø35 0mm	AC000423 
30	24mm	AC000103 	9	2MM	AC000448 
6	3x15mm	AC000201 	38	8x35mm	AC000601 
10	3.5x40mm	AC000203 	1	L=987	AC000902 
20	4x16mm	AC000204 	1	Safety	AC000356 
33	3.5x35mm	AC000219 	1	Glue	AC000607 
48	Ø1.4x25mm	AC000316 	28	Ø14	AC000369-* 
2	15x22mm	AC000335 			
12	Ø5MM	AC000349 			
6	19x14mm	AC000371 			
3	Ø35 9mm	AC000418 			

1

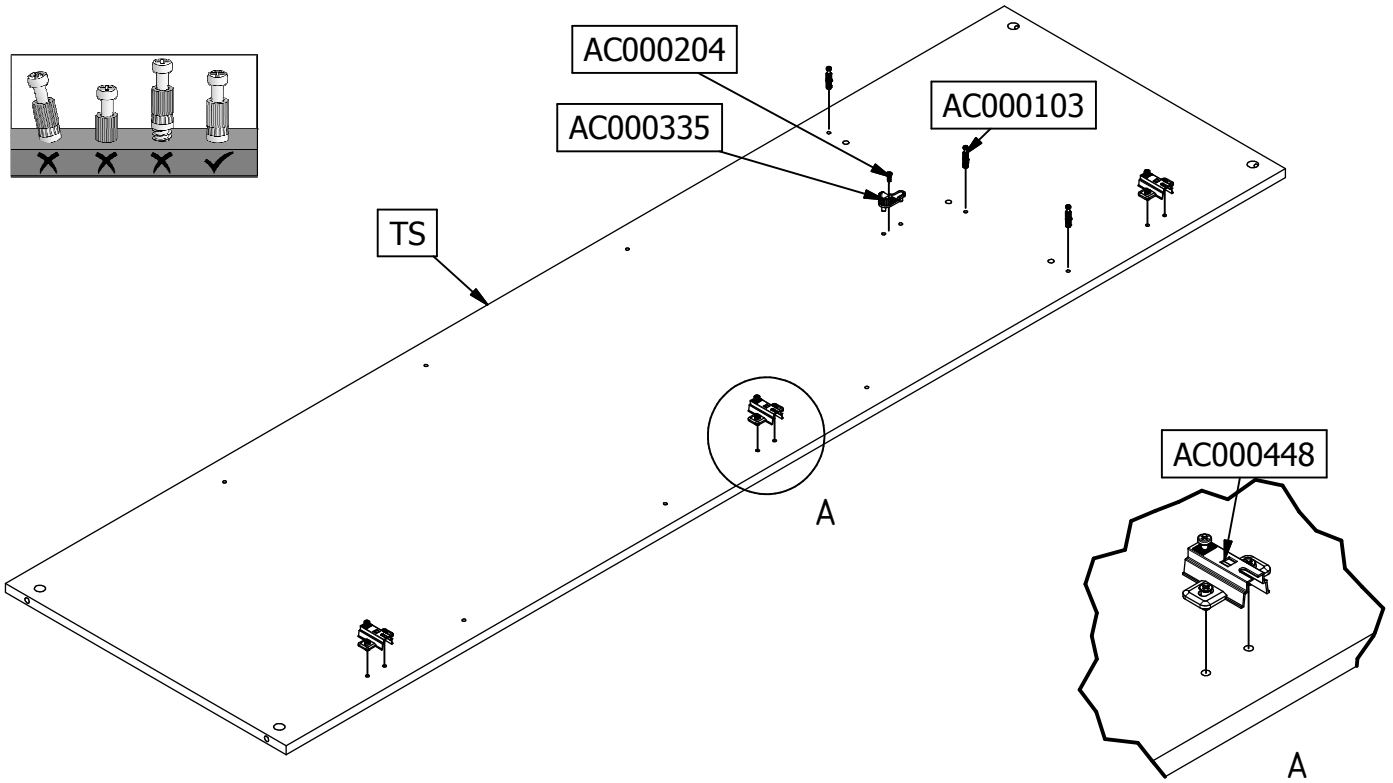
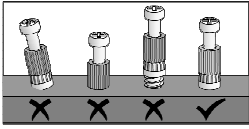
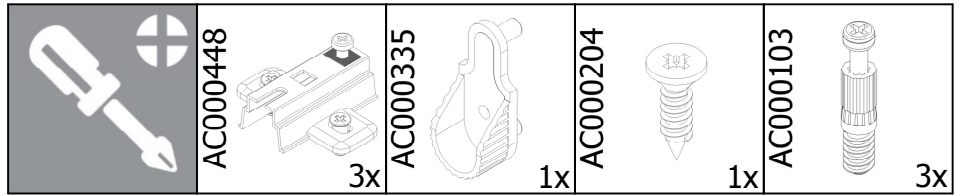

2

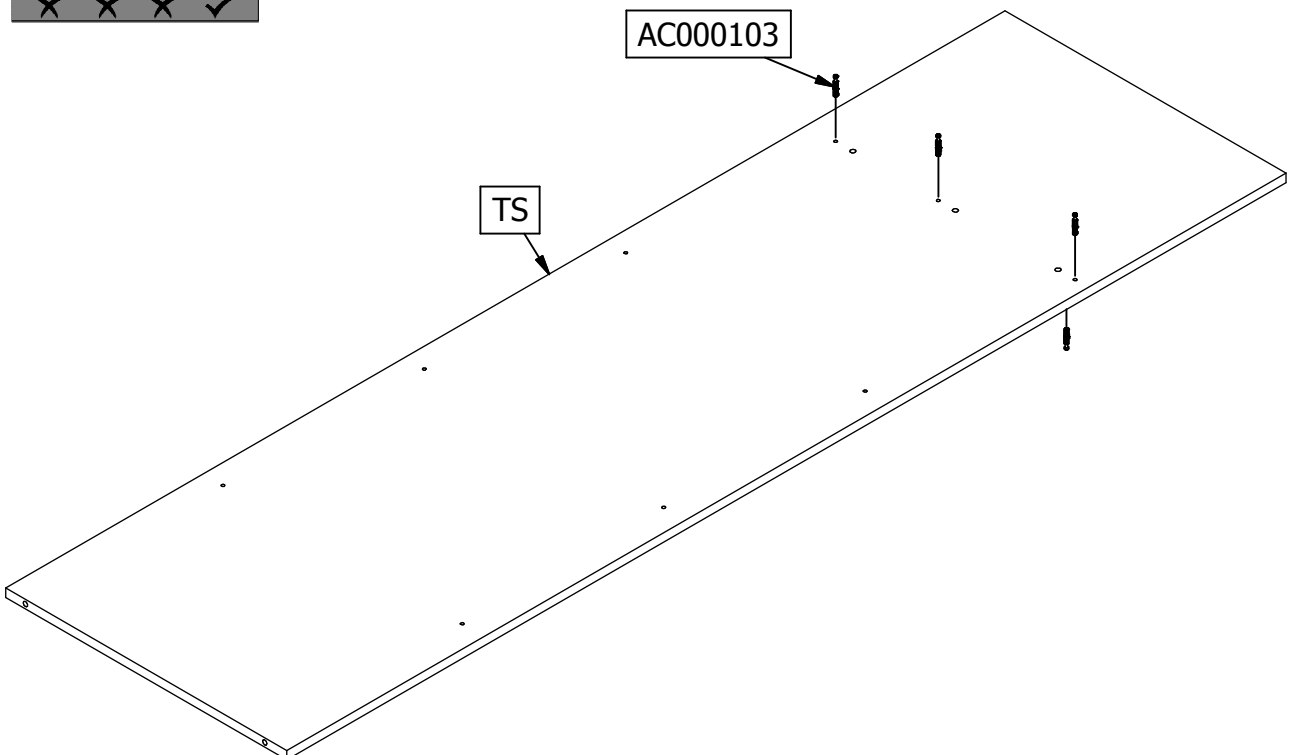
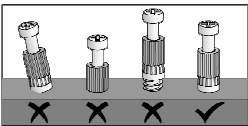
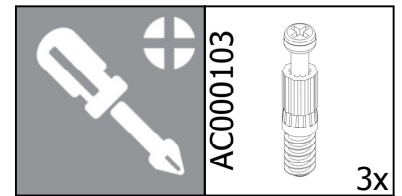

3

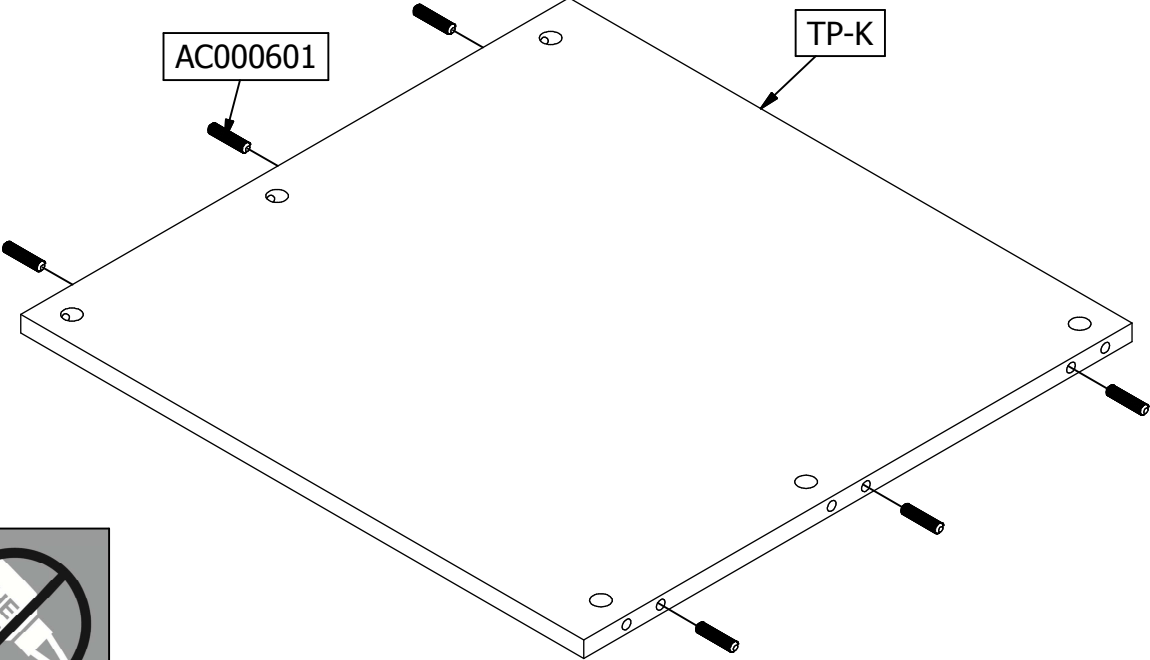
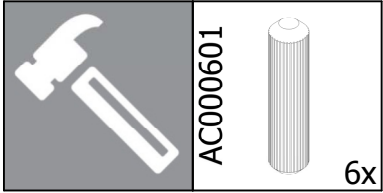

4

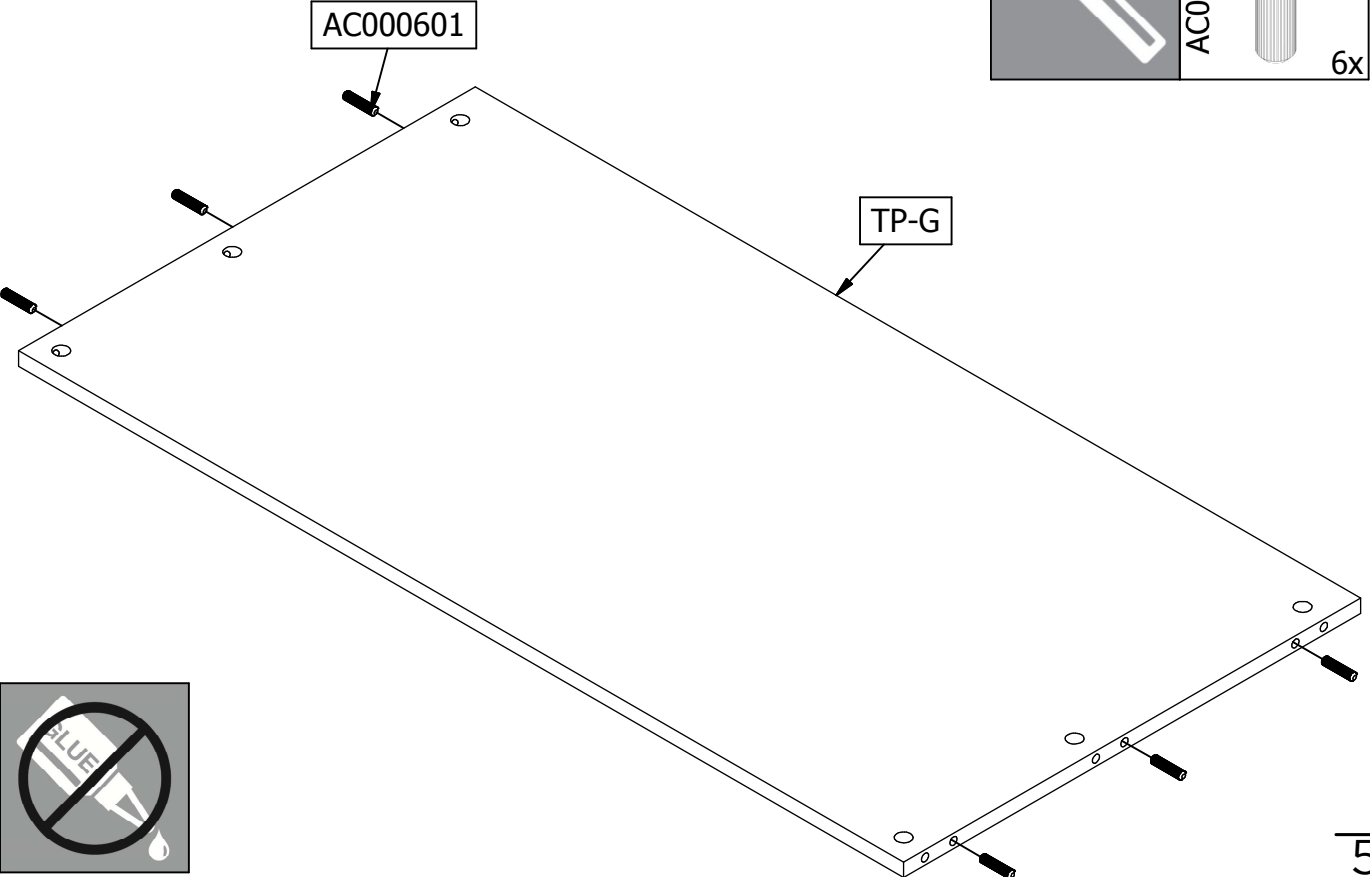
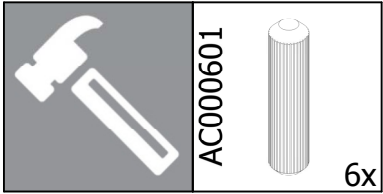

5

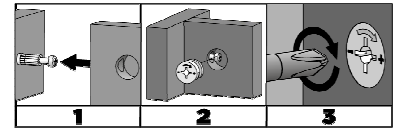
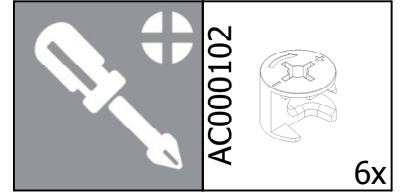
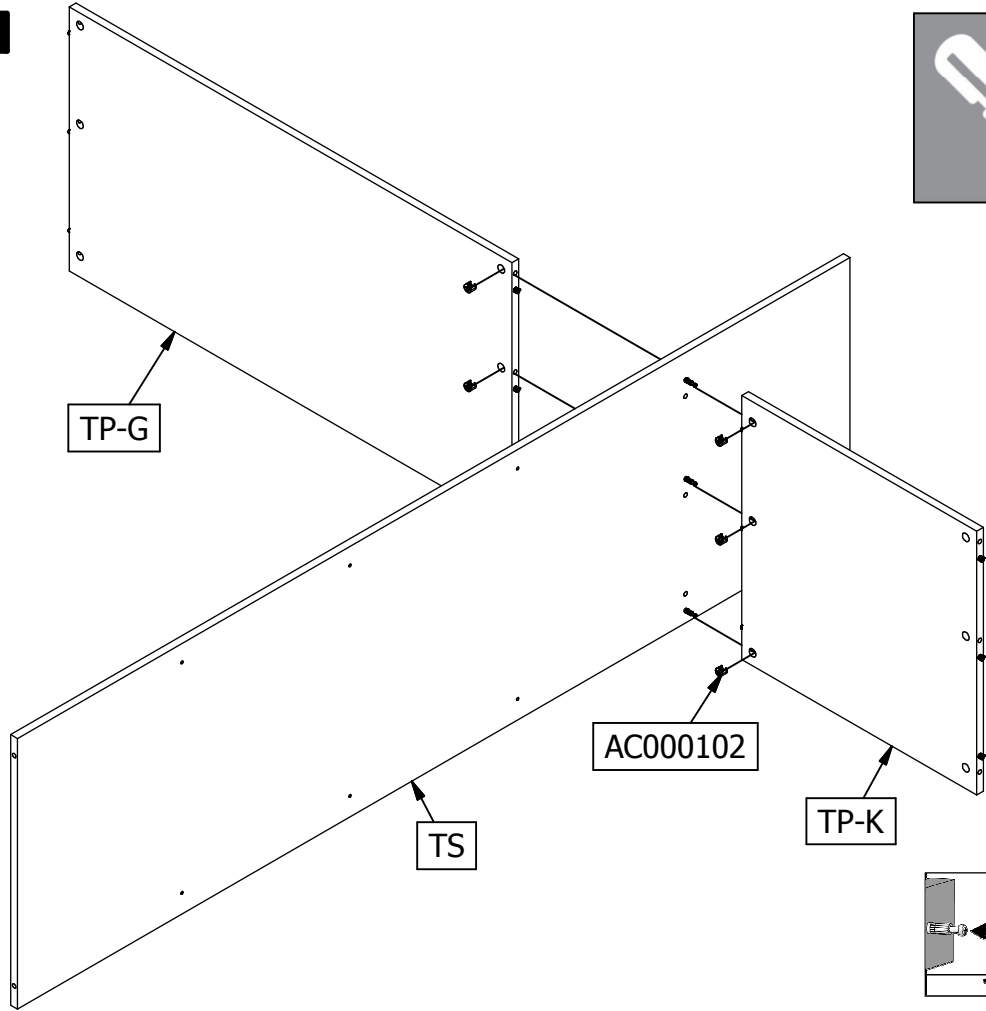

6

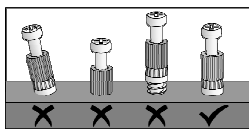
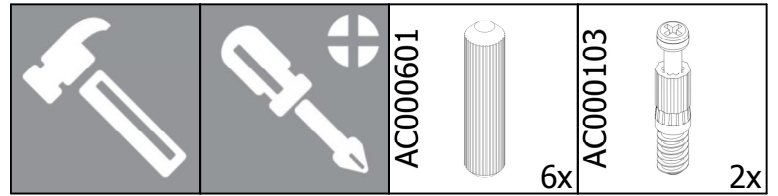
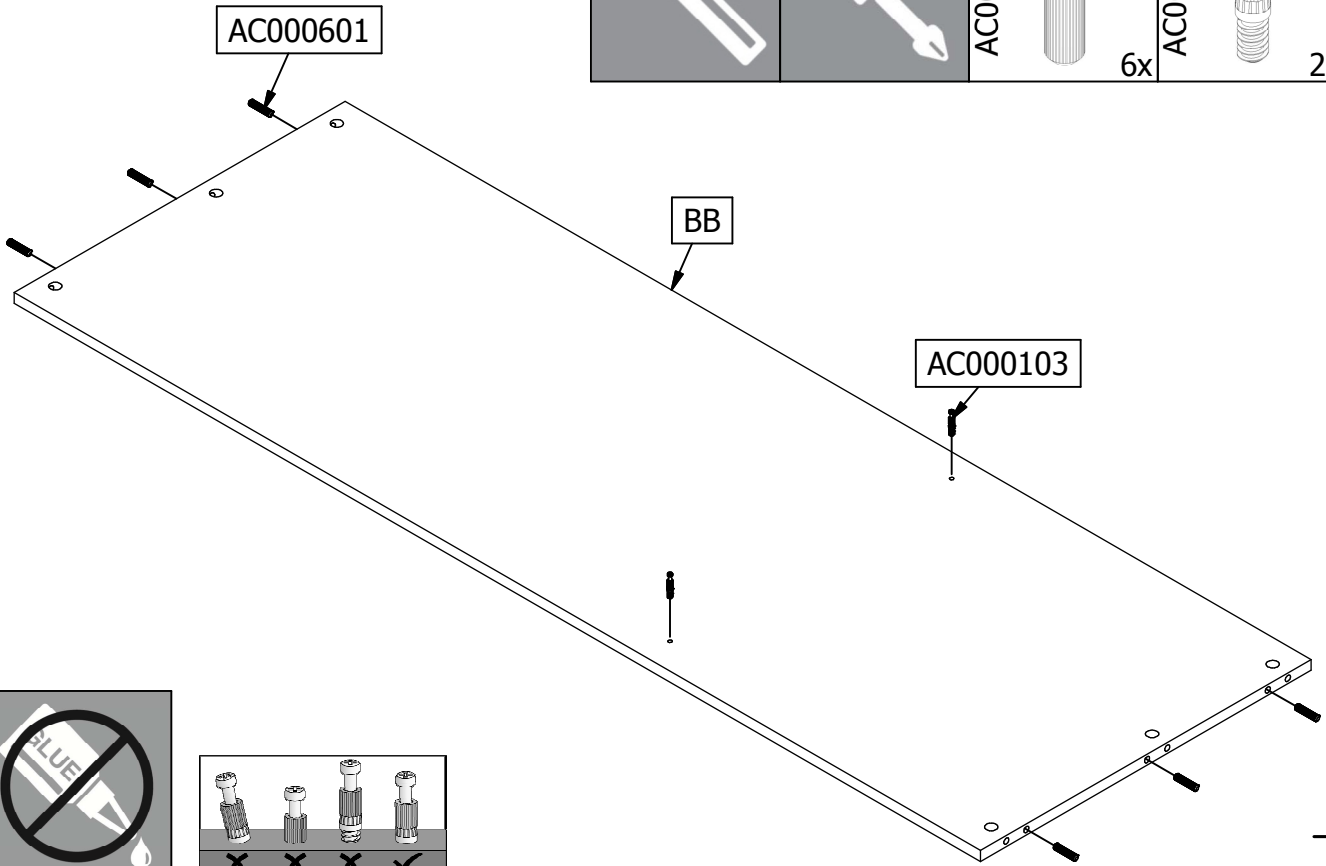

7

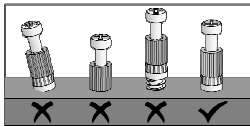
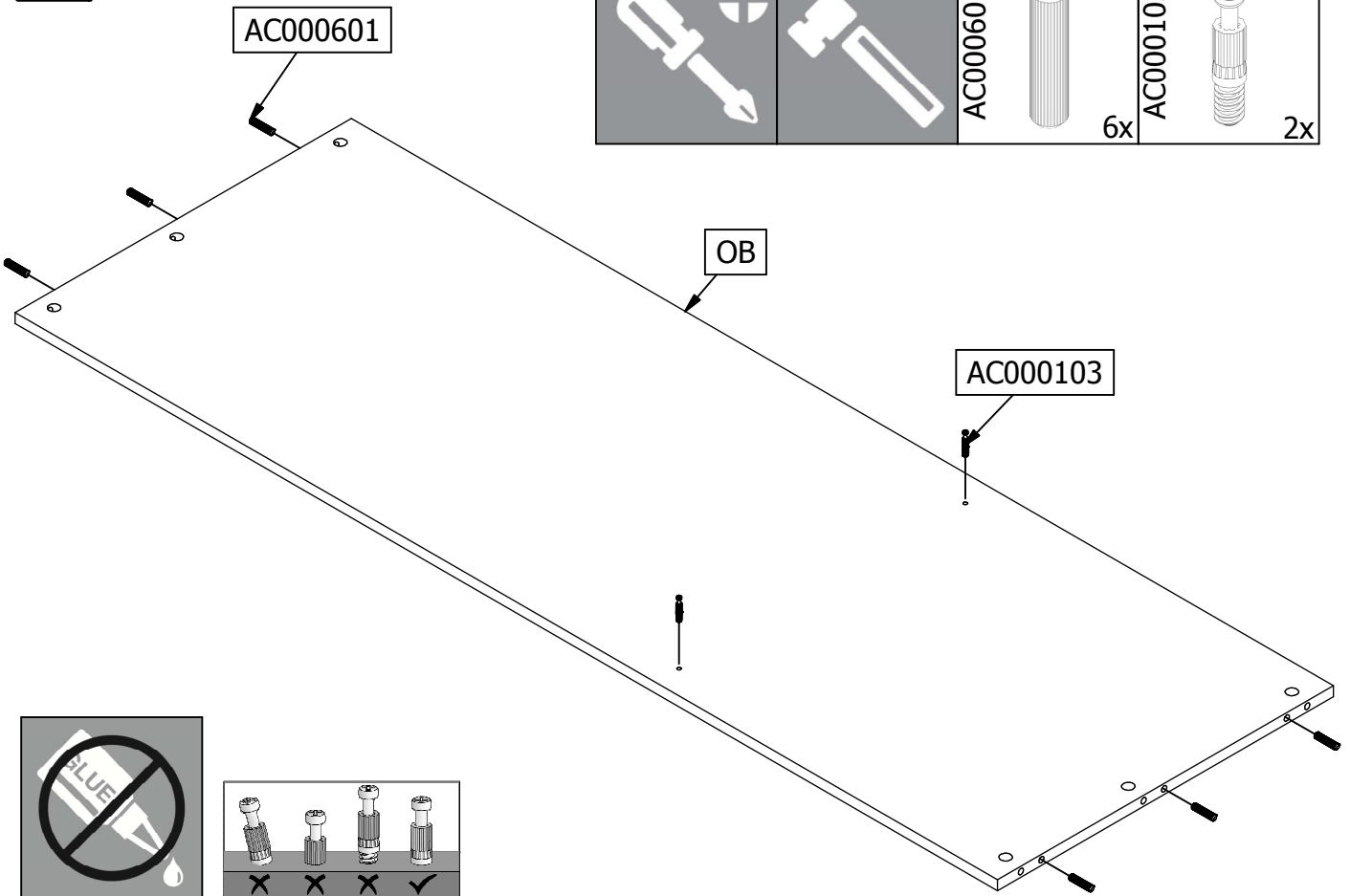
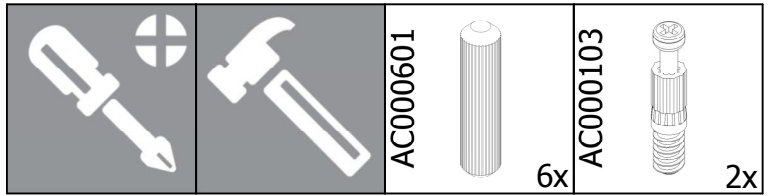

8

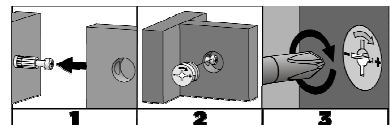
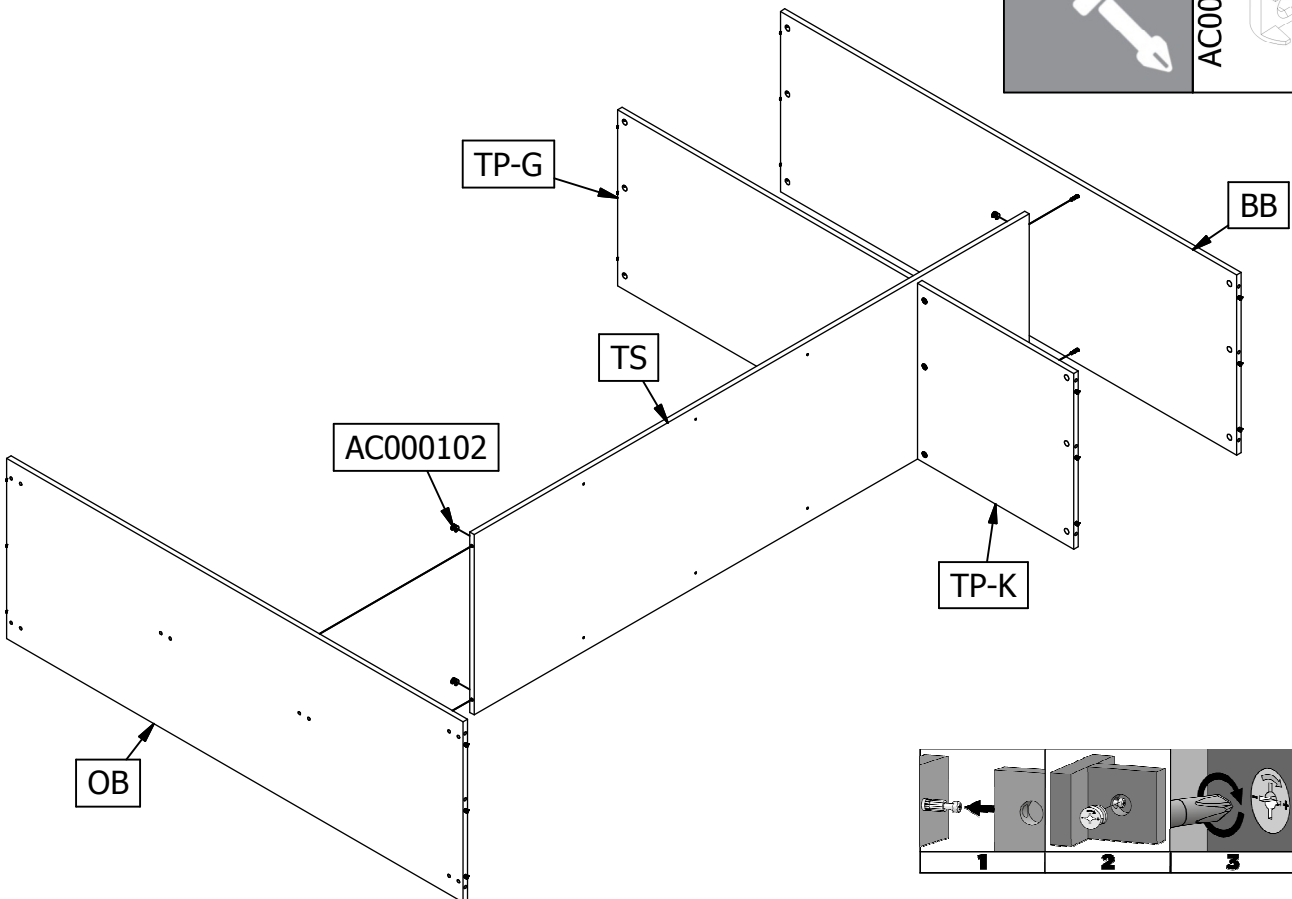
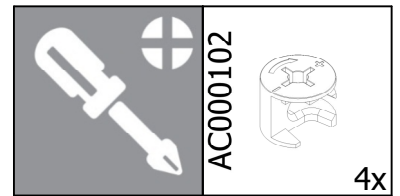

9

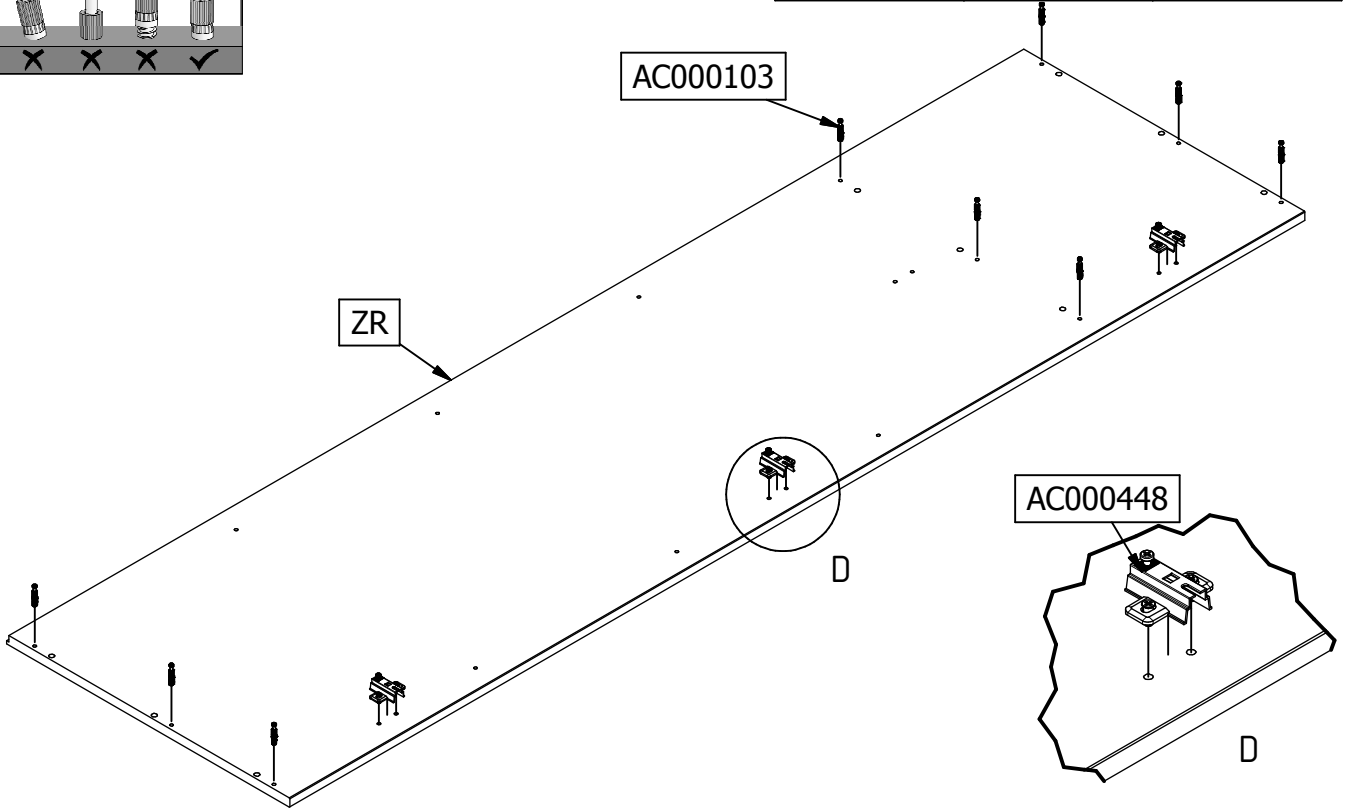
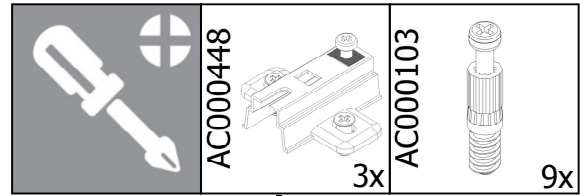
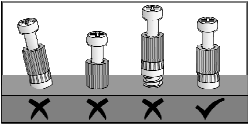

10

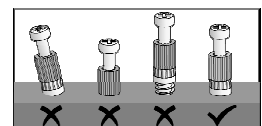
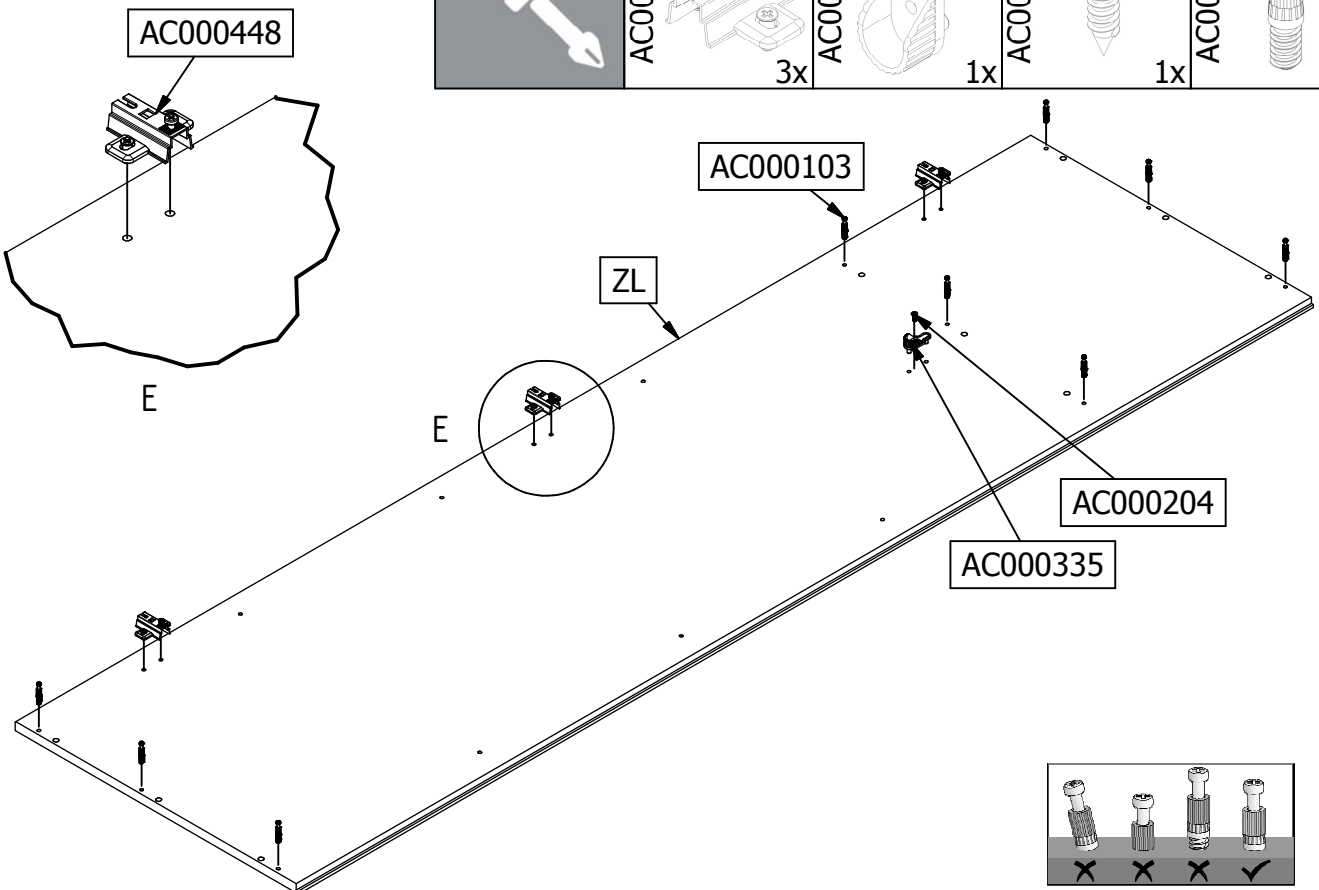
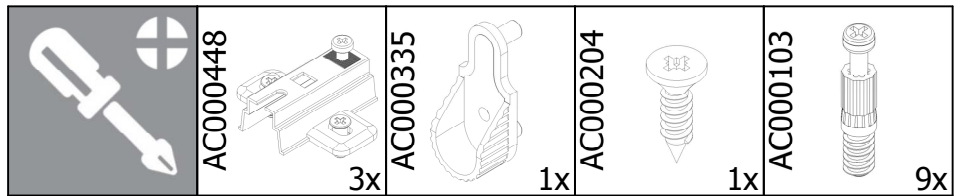



11

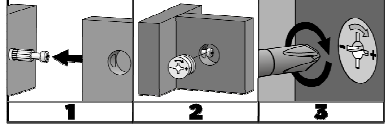
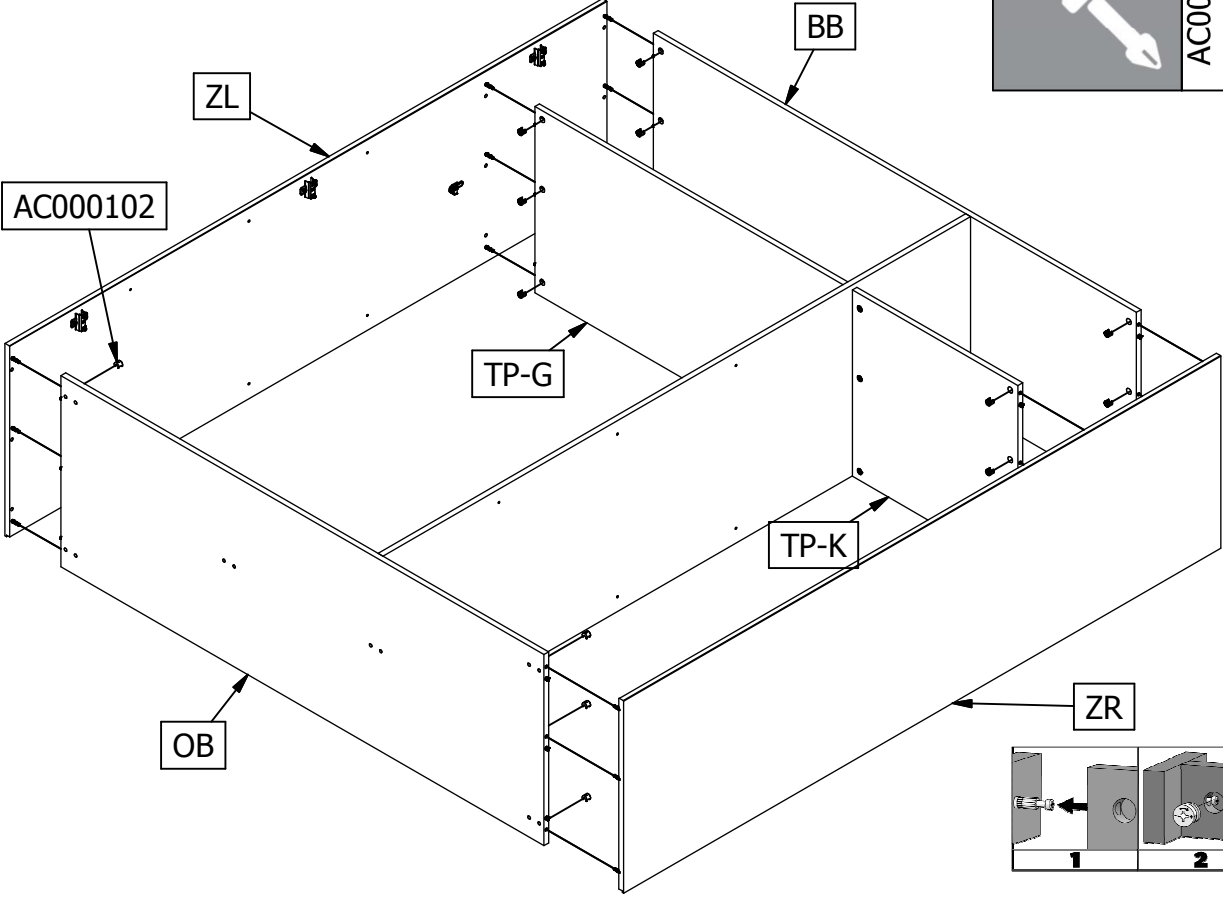
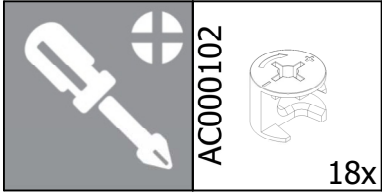

12

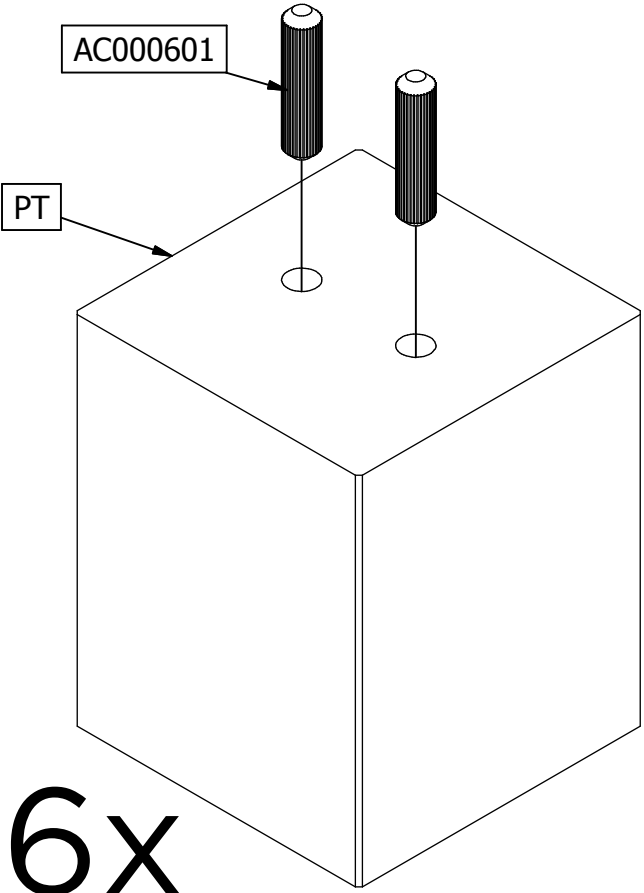
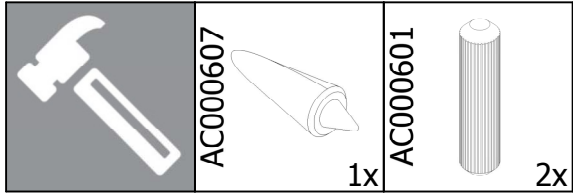

Het gebruik van een klein beetje houtlijm is noodzakelijk voor een goede verbinding  
 Für eine stabile Verbindung ist ein bisschen Holzleim erforderlich  
 Un peu de colle à bois est nécessaire pour un assemblage solide  
 The use of a little wood glue is necessary for proper connection

6x

13

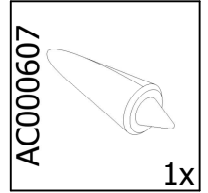
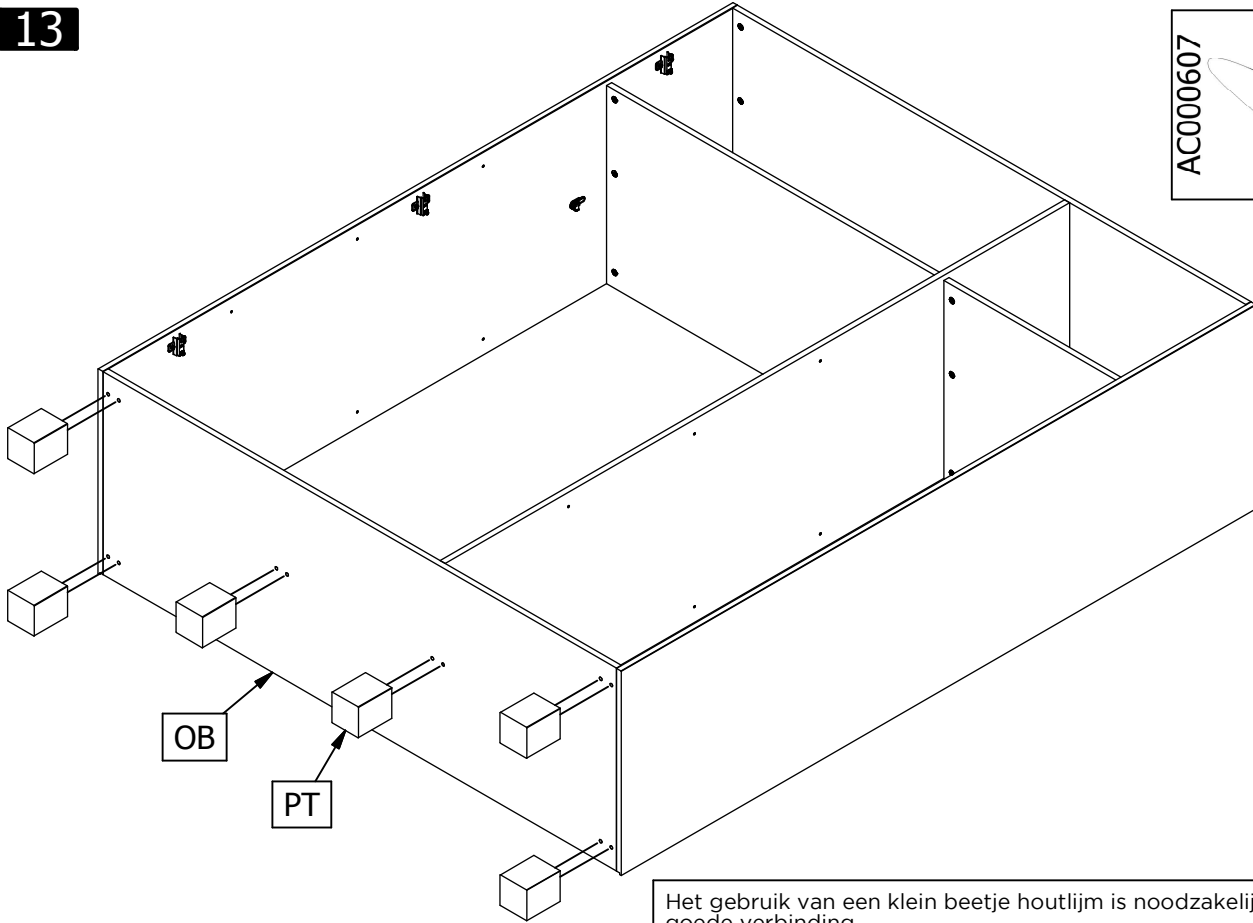

Het gebruik van een klein beetje houtlijm is noodzakelijk voor een goede verbinding  
 Für eine stabile Verbindung ist ein bisschen Holzleim erforderlich  
 Un peu de colle à bois est nécessaire pour un assemblage solide  
 The use of a little wood glue is necessary for proper connection

14

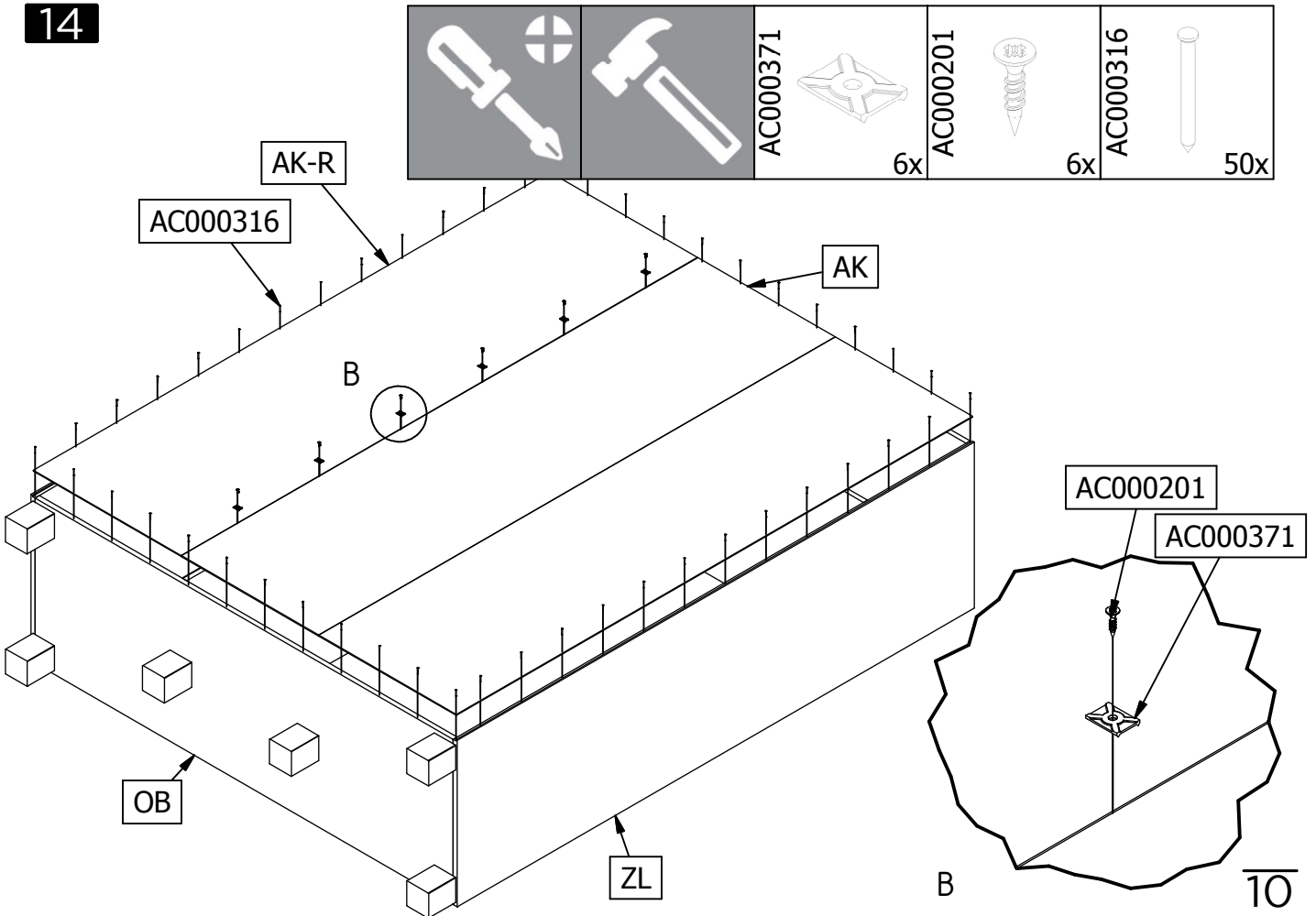

10

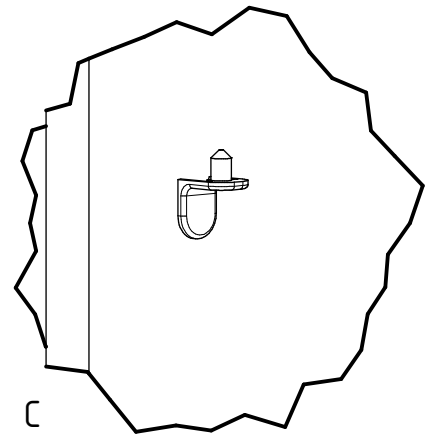
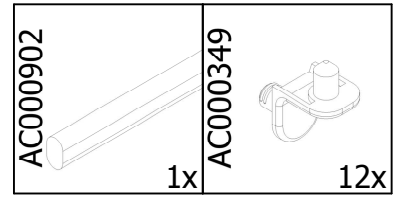
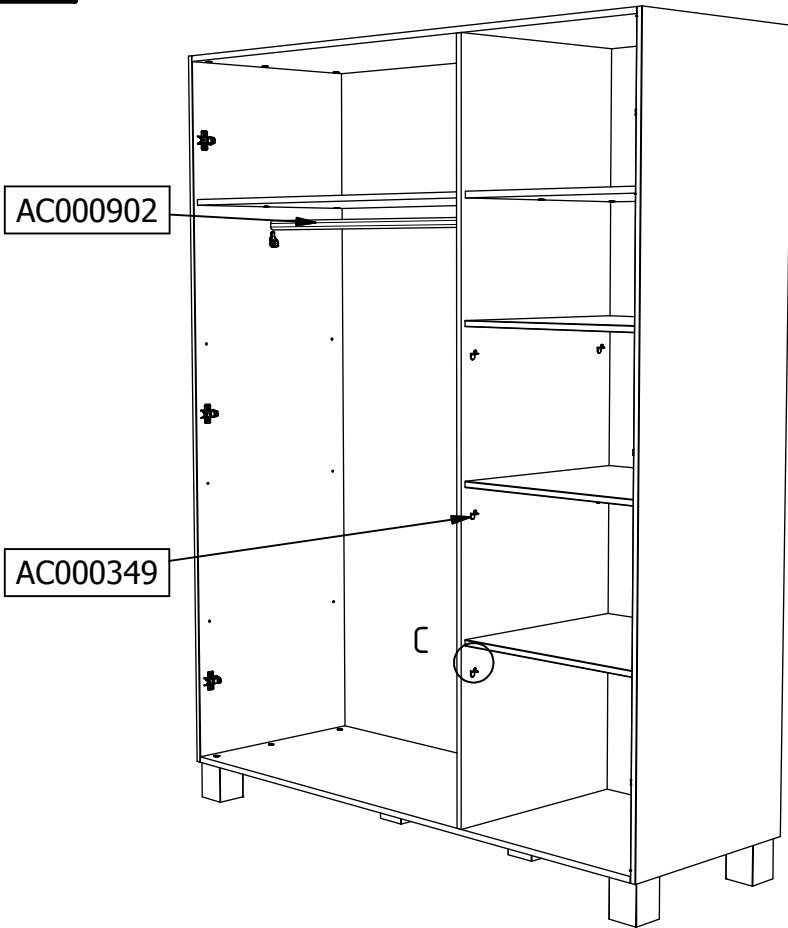

15



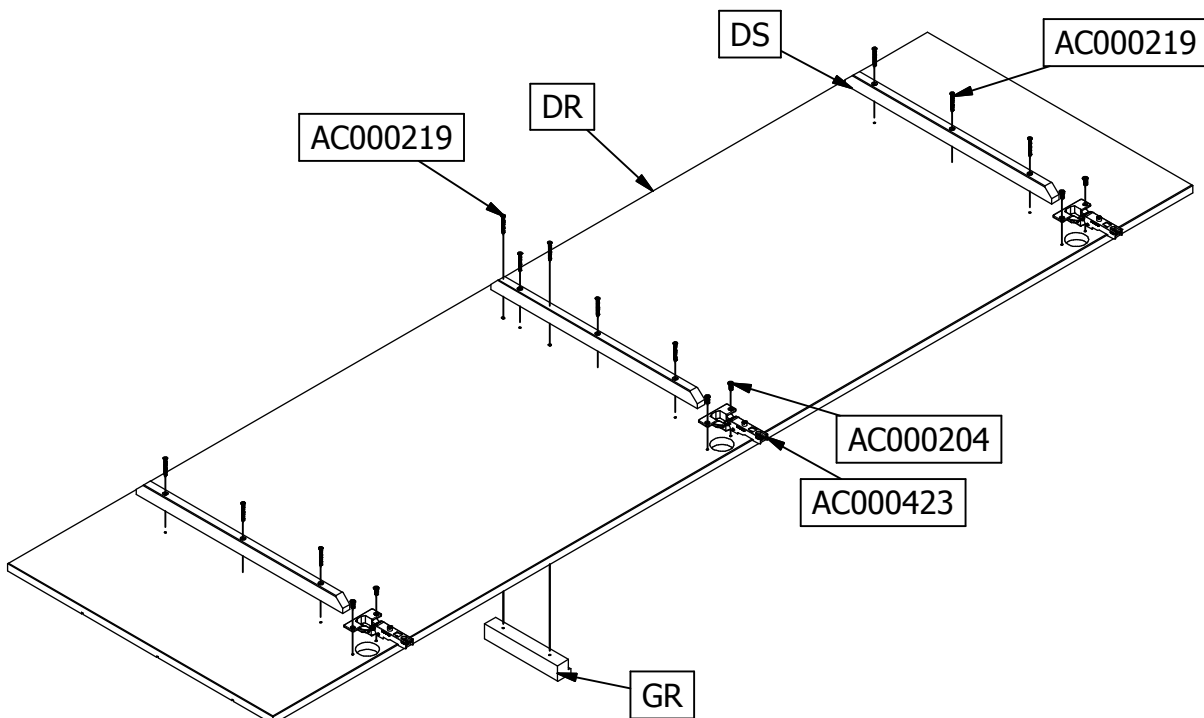
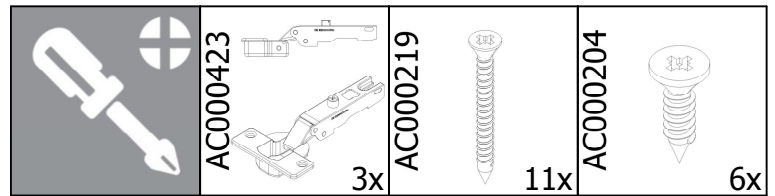

16

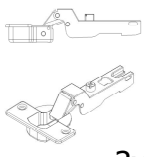
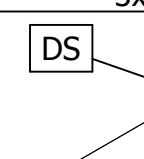

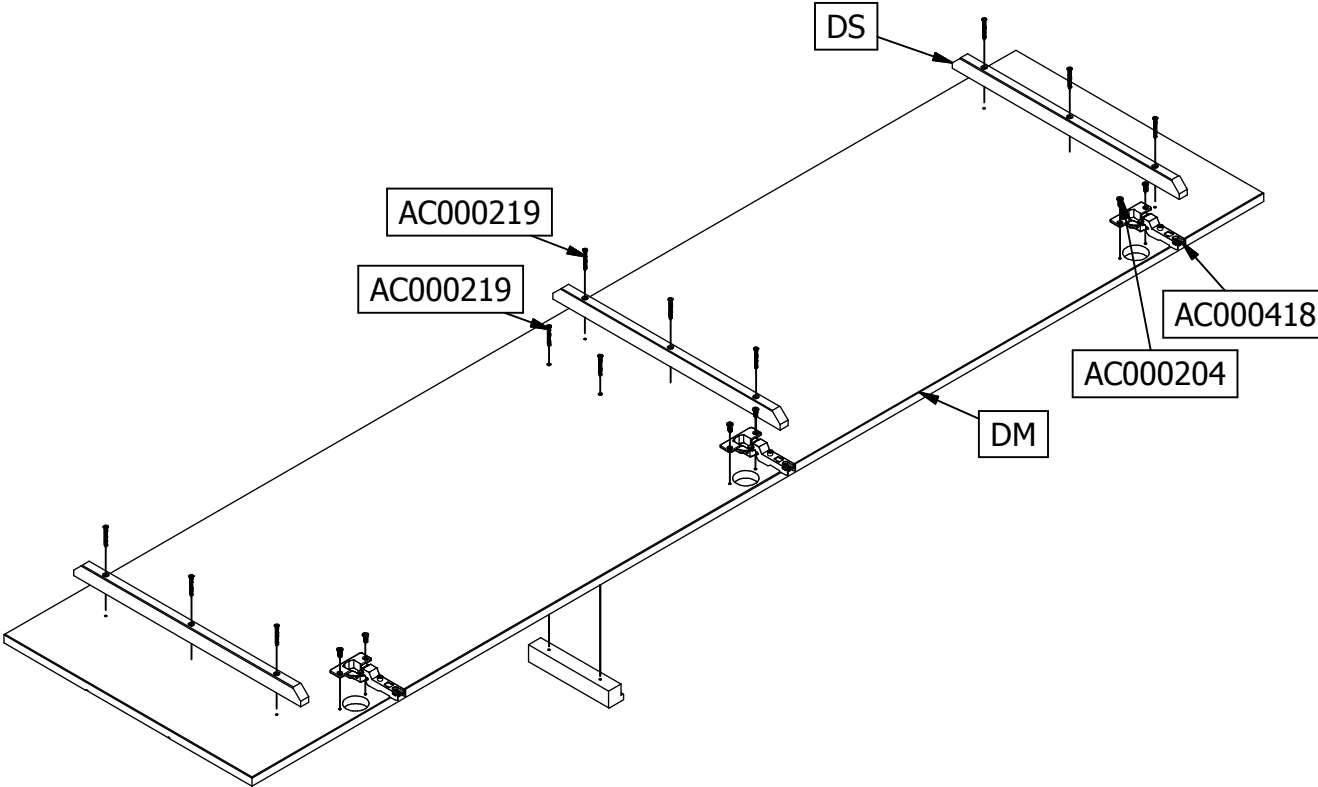
17

	 AC000418	 3x	 AC000219 11x	 AC000204 6x
				

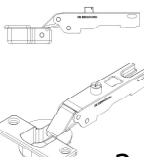
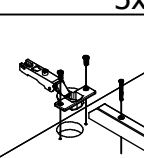
18

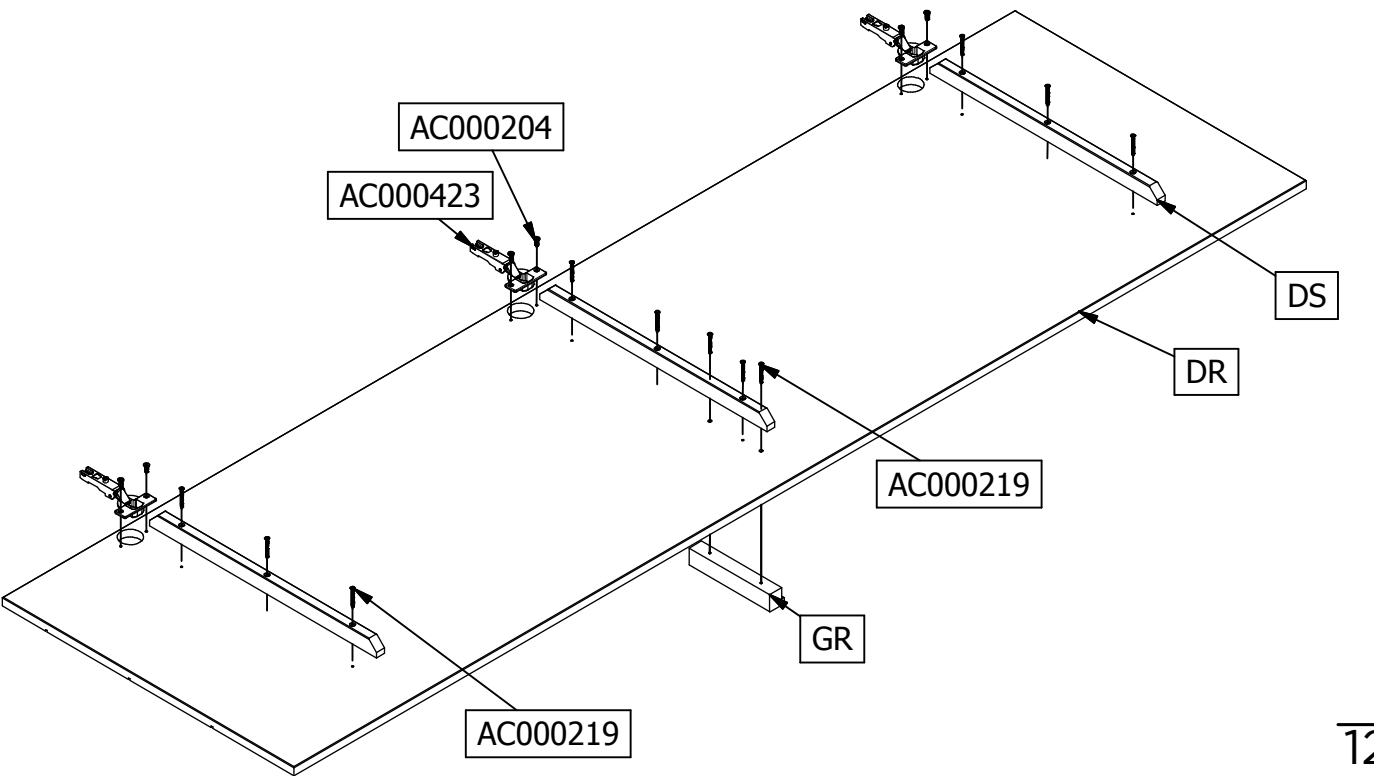
	 AC000423	 3x	 AC000219 11x	 AC000204 6x
				

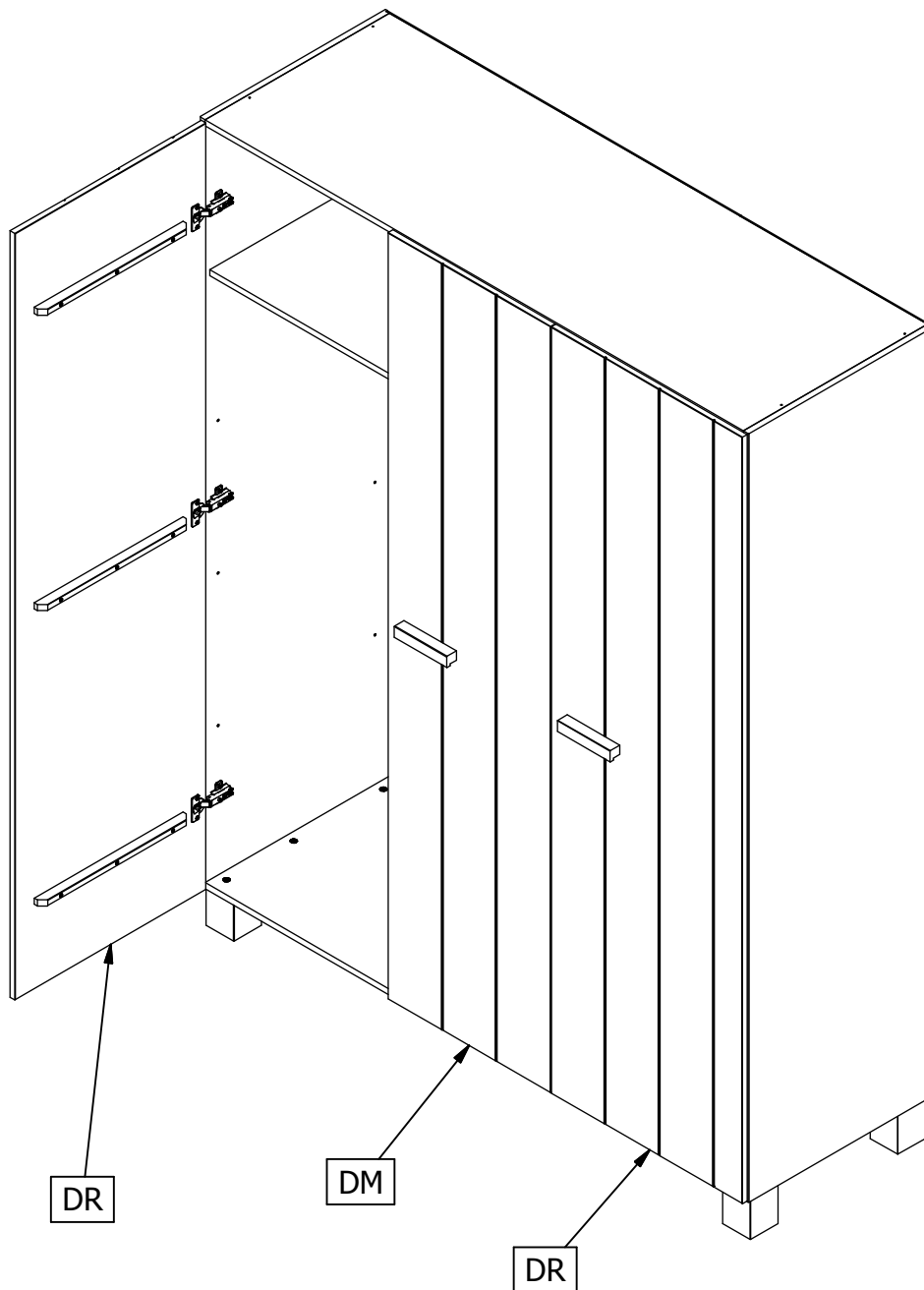

- A. Deze schroef gebruiken wanneer u de kieren tussen de deuren en beide zijden groter of kleiner wilt hebben.  
 B. Door deze schroeven iets los te draaien kunt u de scharnierplaatjes verstellen zodat de deuren hoger of lager bevestigd kunnen worden.  
 C. Met deze schroef draait u de deur vast.

- A. Diese Schraube benutzen, wenn der Spalt Zwischen der Tür und den Seiten größer oder kleiner sein soll.  
 B. Wenn Sie diese Schrauben ein wenig lösen, können Sie die Scharnierplatten verstellen, um so die Tür höher oder niedriger zu befestigen.  
 C. Mit dieser Schraube befestigen Sie die Tür.

- A. Utilisez cette vis, si vous voulez agrandir ou réduire la fente entre la porte et les deux côtés de l'armoire.  
 B. En dévissant ces vis quelque peu, vous pouvez régler les charnières pour accrocher ensuite la porte plus haute ou plus basse.  
 C. Fixez la porte à l'aide de cette vis.

- A. Adjusting this screw will position doors horizontally (changes gap between doors)  
 B. By releasing this screw the position of mounting plates of the hinges can be repositioned so that vertical position of doors can be adjusted (higher//lower)  
 C. This screw fixes the door.

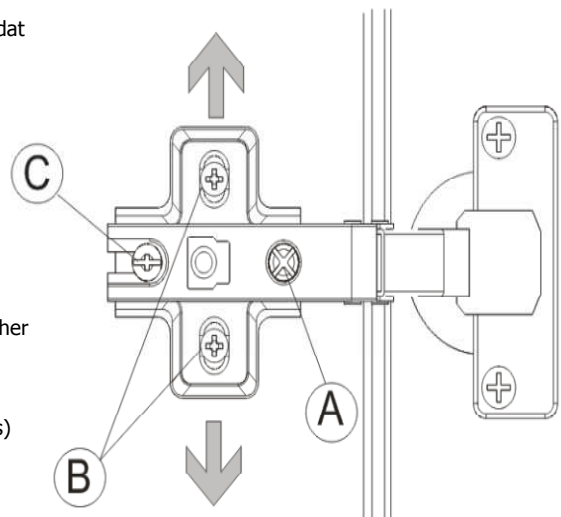

20

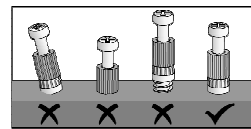
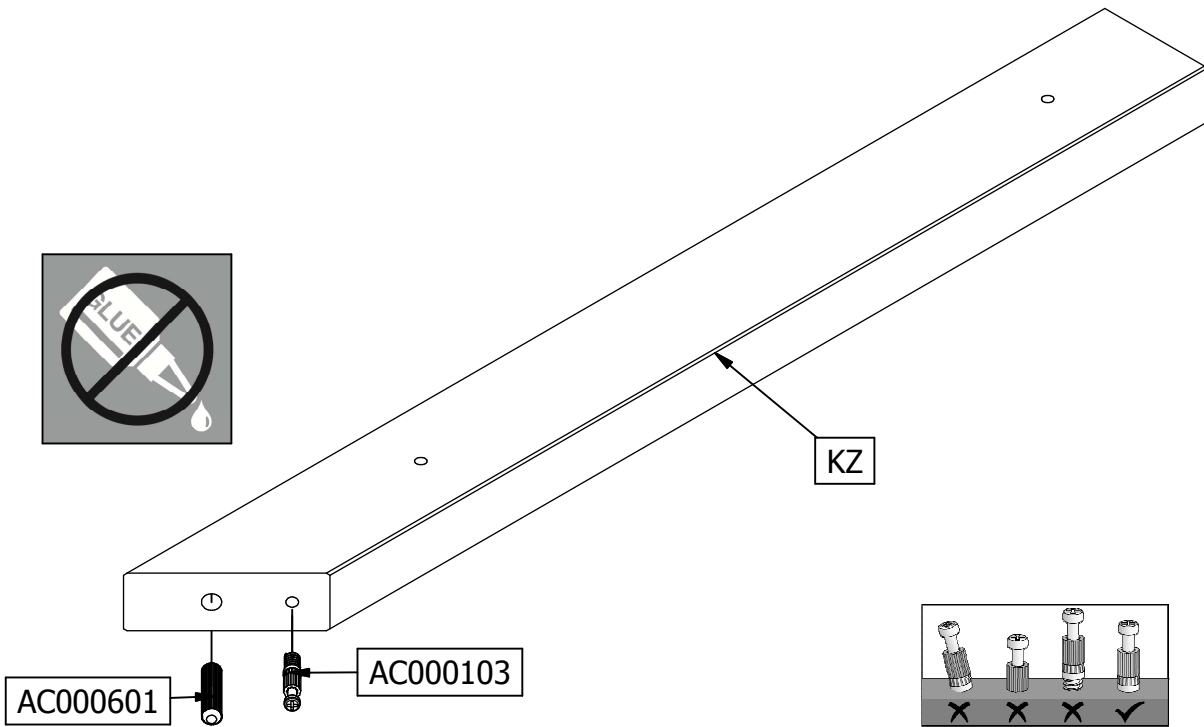
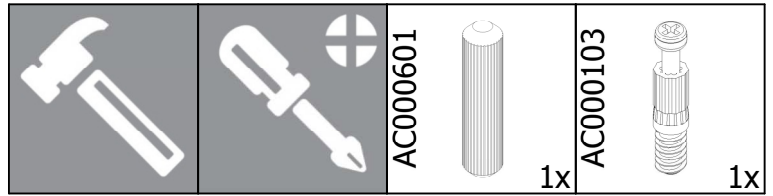

2x

21

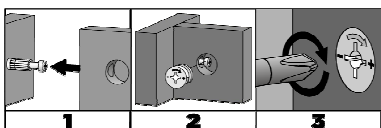
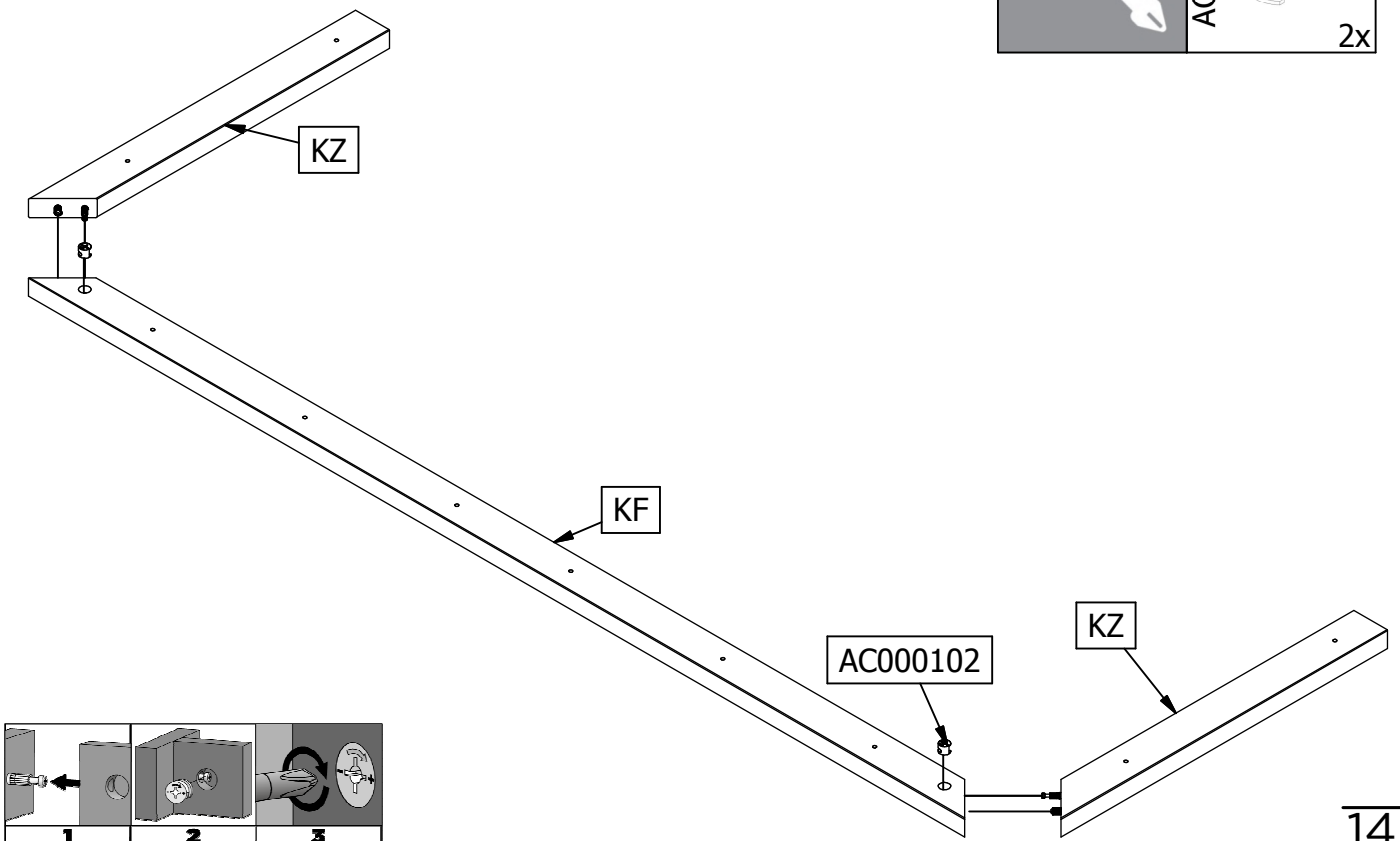
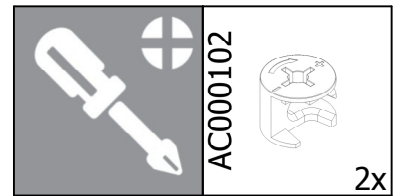

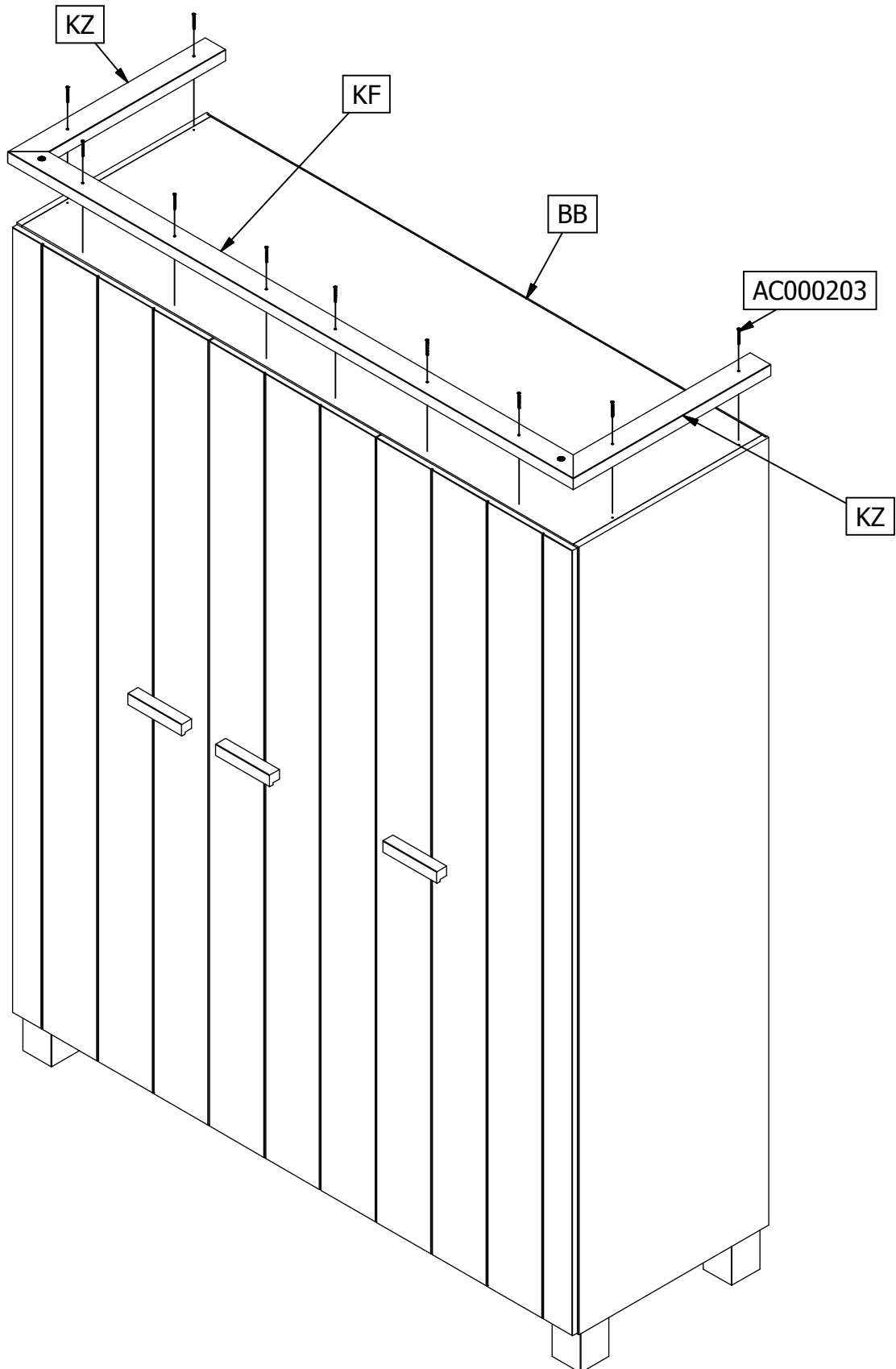
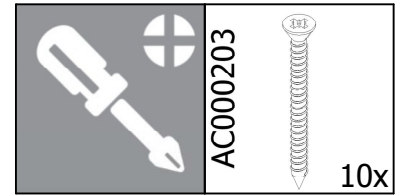

## **SOCIAL MEDIA**

We are curious about the result! Would you like to share it with us? Use #WOOOD on social media.  
Wir sind gespannt auf das Ergebnis! Möchten Sie es mit uns teilen? Benutzen Sie #WOOOD in Social Media.

Nous sommes impatient de connaître le résultat. Souhaitez-vous le partager avec nous? Utilisez #WOOOD sur les médias sociaux.



[facebook.com/wood.nl](https://facebook.com/wood.nl)  
[instagram.com/madebywood](https://instagram.com/madebywood)  
[pinterest.com/madebywood](https://pinterest.com/madebywood)