

NOUS

GARDEN

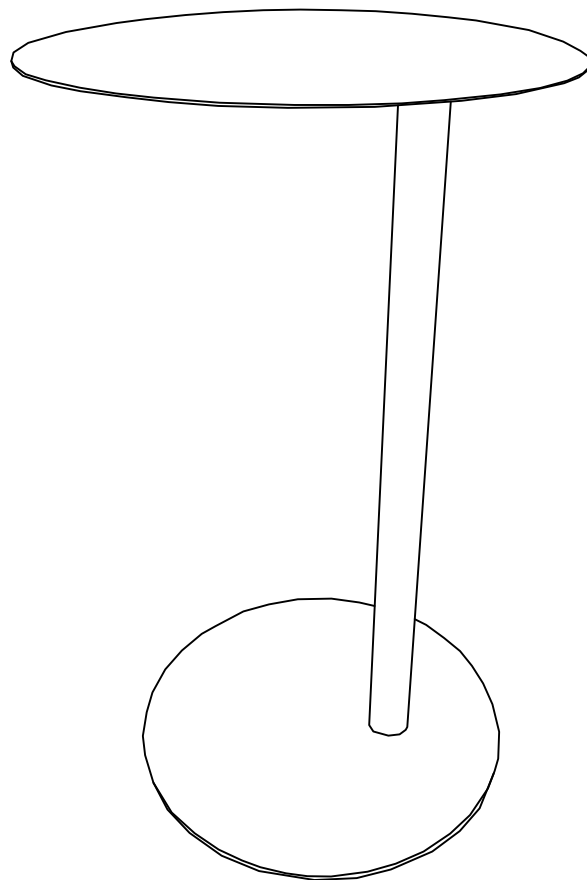

LA ZARZA BIJZETTAFEL

Let op:

Om beschadiging te voorkomen, sleep het meubelstuk niet, maar til het op wanneer je het verplaatst.
Plaats de onderdelen op een zachte ondergrond tijdens montage.
Draai schroeven pas helemaal aan als alle schroeven gemonteerd zijn.

Please note:

To prevent potential damage, don't drag the piece of furniture but always lift it when moving.
Place the parts on a soft surface during assembly.
Do not fully tighten screws until all screws have been installed.

NOUS

GARDEN

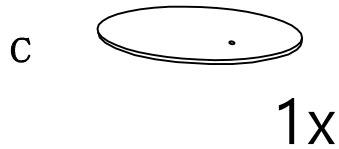
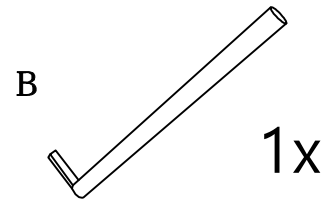
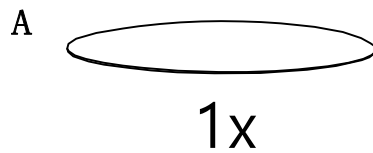
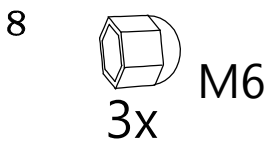
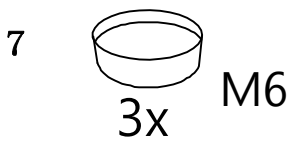
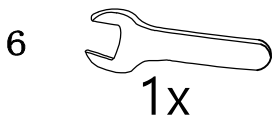
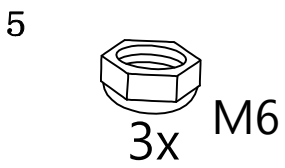
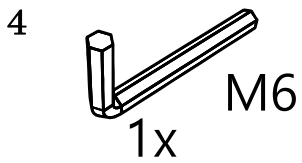
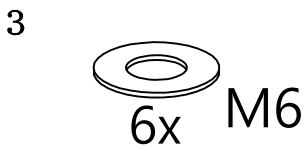
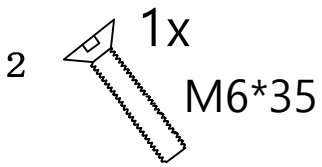
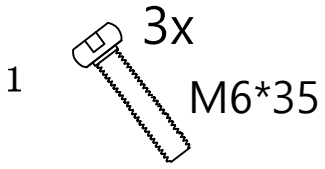

NOUS

GARDEN

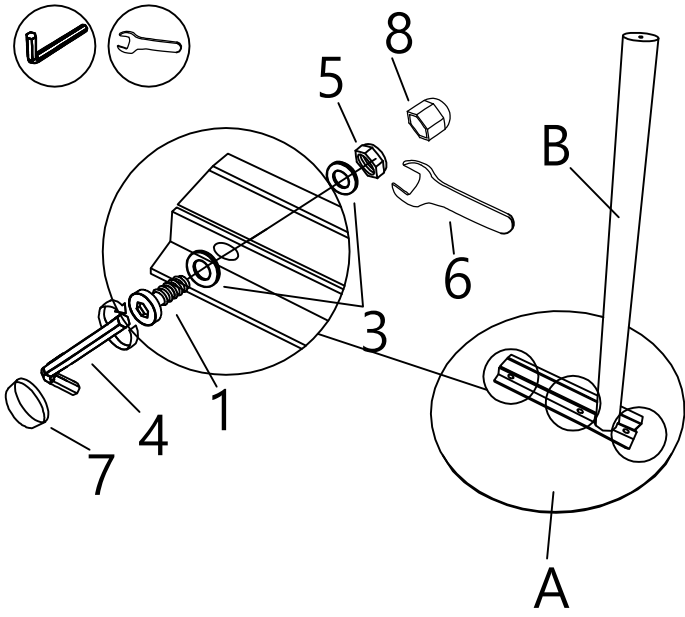
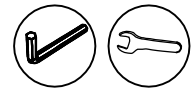

①

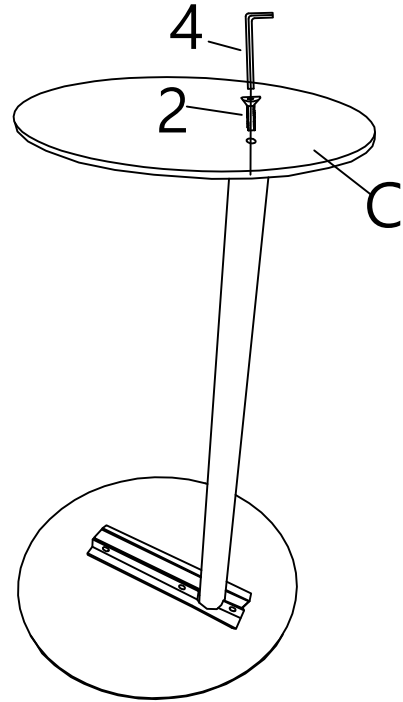

②

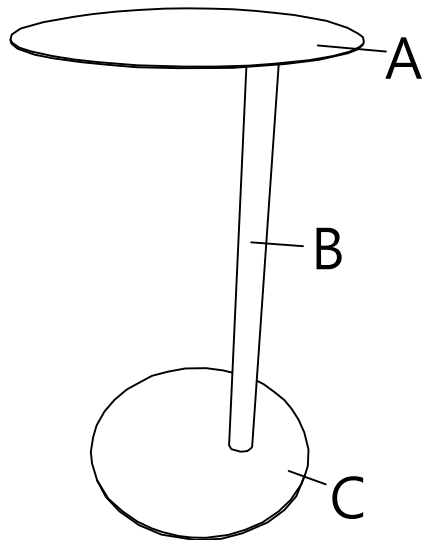

③

STUDIO. LIVIT

Aandachtspunten:

- Laat bij warmte geen glazen lang op tafel staan om kringen te voorkomen.
- Bij knoeien met koffie, thee, sap, olie, etc. snel schoonmaken met keukenpapier of vochtige doek.
- Schroeven geleidelijk aandraaien en pas als alles in elkaar zit strak aandraaien.
- De bouten niet strak aandraaien voordat het product volledig geassembleerd is.
- Gebruik alleen het in de verpakking meegeleverde gereedschap, geen elektrisch gereedschap gebruiken.
- AUB, controleer maandelijks of alle bevestigingen nog strak aangespannen zijn.

Points of attention:

- Do not leave glasses on the table for long periods in hot weather to prevent rings.
- If coffee, tea, juice, oil, etc. is spilled, clean it quickly with a paper towel or damp cloth.
- Tighten screws gradually and only tighten them once everything is assembled.
- Do not tighten the bolts until the product is fully assembled.
- Use only the tools provided in the packaging; do not use power tools.
- Please check monthly that all fasteners are still tight.