

NOUS

GARDEN

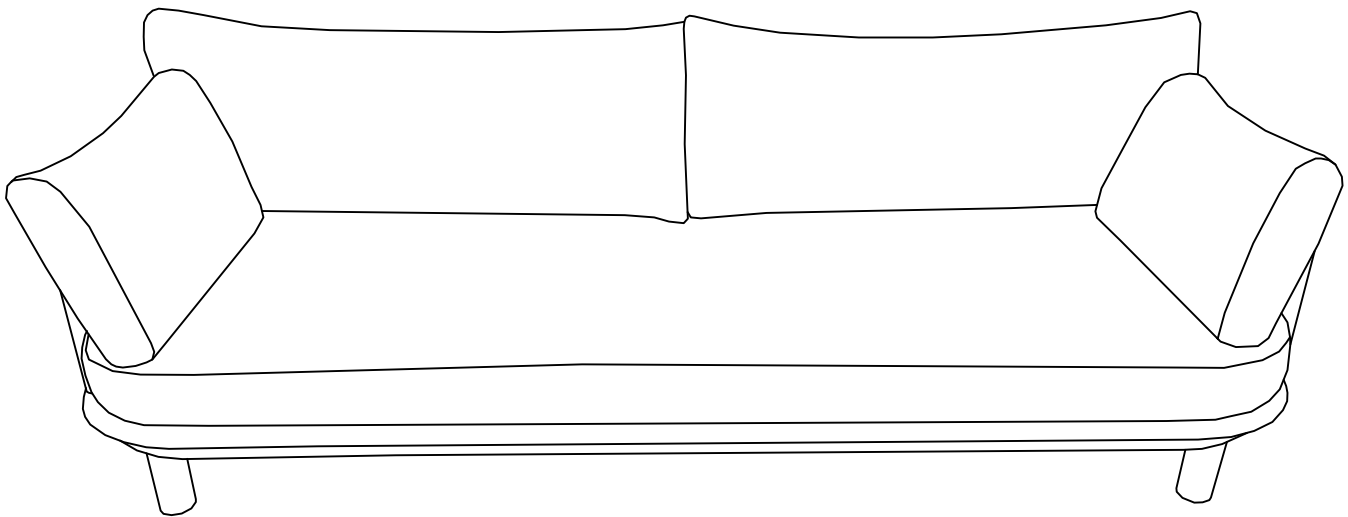
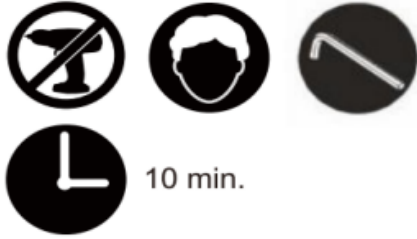

LA COLINA LOUNGEBANK

Let op:

Om beschadiging te voorkomen, sleep het meubelstuk niet, maar til het op wanneer je het verplaatst.
Plaats de onderdelen op een zachte ondergrond tijdens montage.
Draai schroeven pas helemaal aan als alle schroeven gemonteerd zijn.

Please note:

To prevent potential damage, don't drag the piece of furniture but always lift it when moving.
Place the parts on a soft surface during assembly.
Do not fully tighten screws until all screws have been installed.

NOUS GARDEN

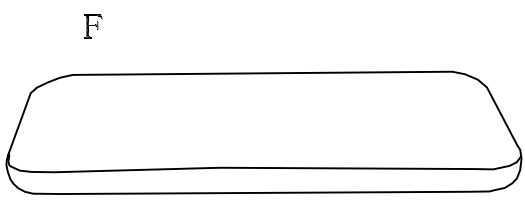
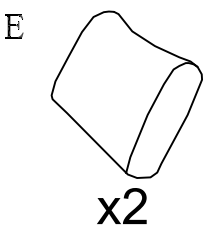
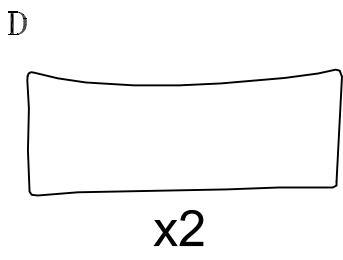
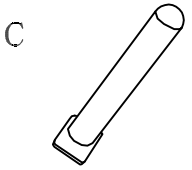
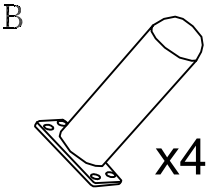
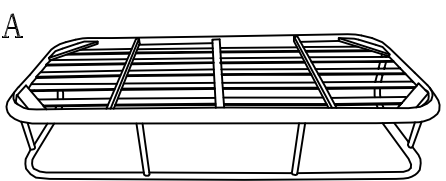
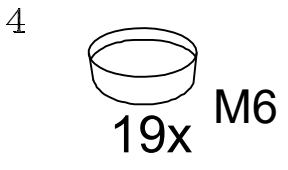
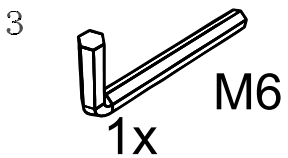
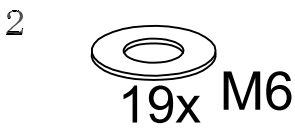
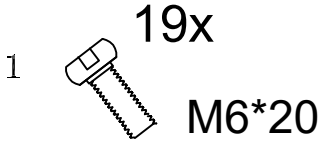

NOUS GARDEN

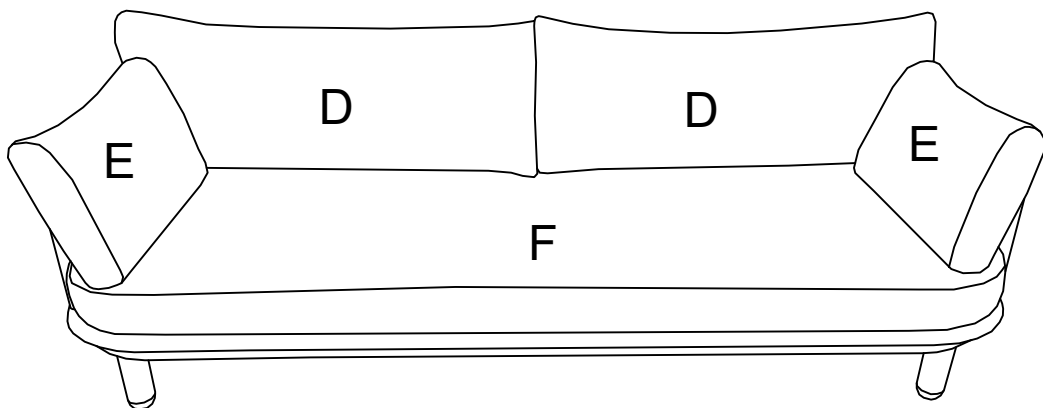
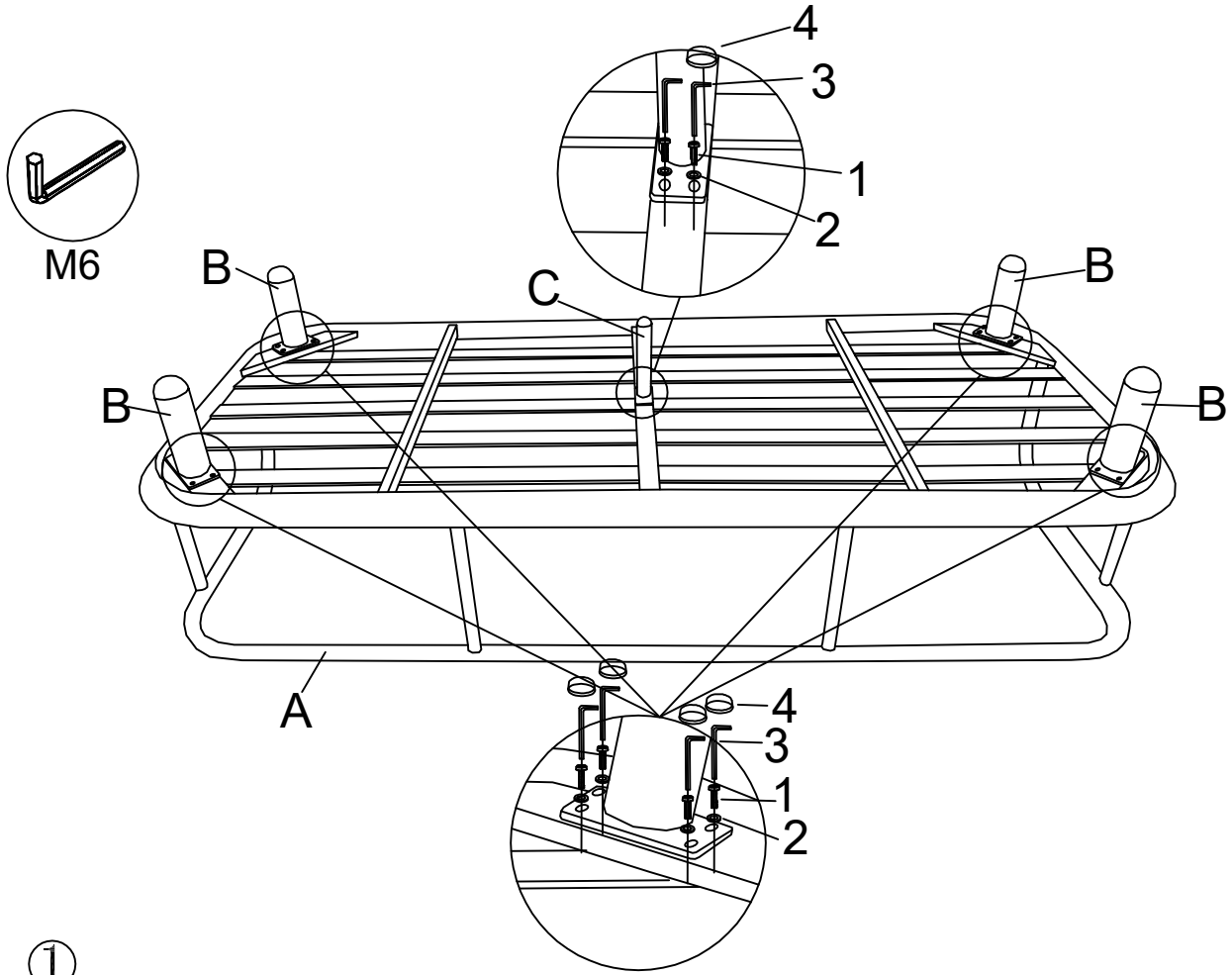

NOUS

GARDEN

Aandachtspunten:

Draai de schroeven gelijkmatig en niet te hard aan.

Reinigen van alle delen (ook arm en rug) kan met een vochtige doek met milde groene zeep.

Bescherm tegen stof, vuil, regen, etc. met een hoes. Haalkussens zo mogelijk binnen. In winter bank binnen opslaan.

Points of attention:

Tighten the screws evenly and not too hard.

Clean all parts (including the arm and back) with a damp cloth and mild green soap.

Protect from dust, dirt, rain, etc. with a cover. Store the cushions indoors if possible.

Store the sofa indoors during the winter.