

STEP 1

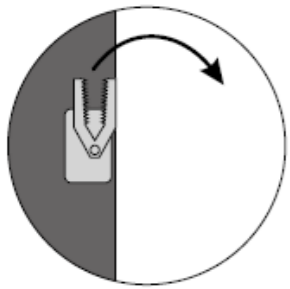

STEP 2

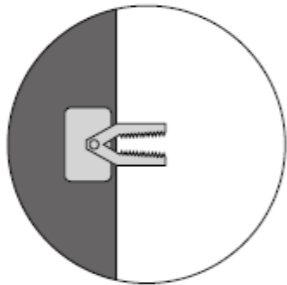

STEP 3

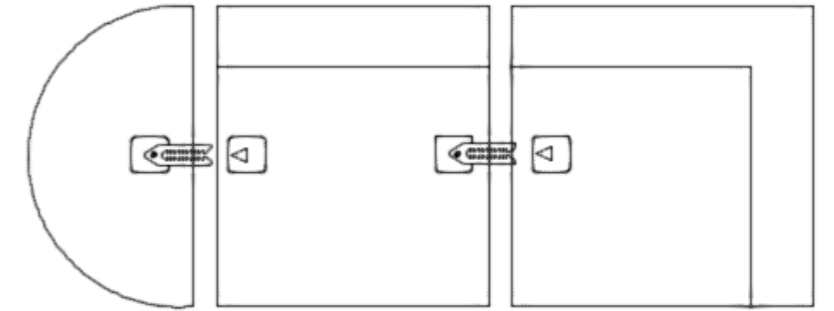
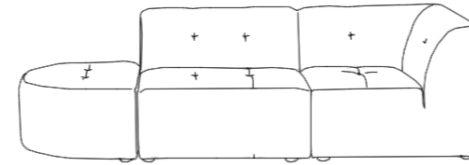
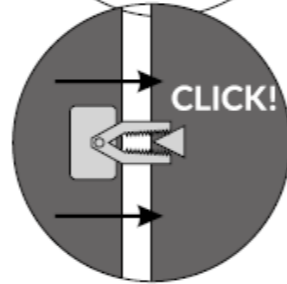

STEP 1

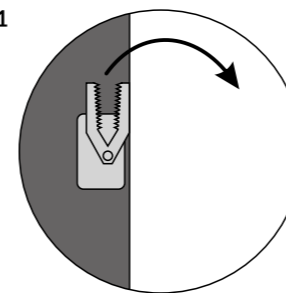

STEP 2

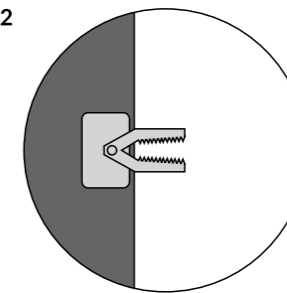

STEP 3

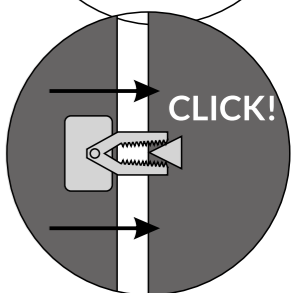
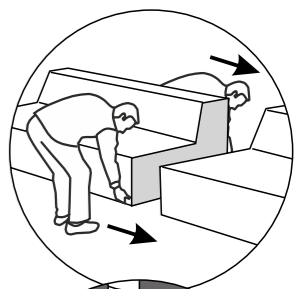

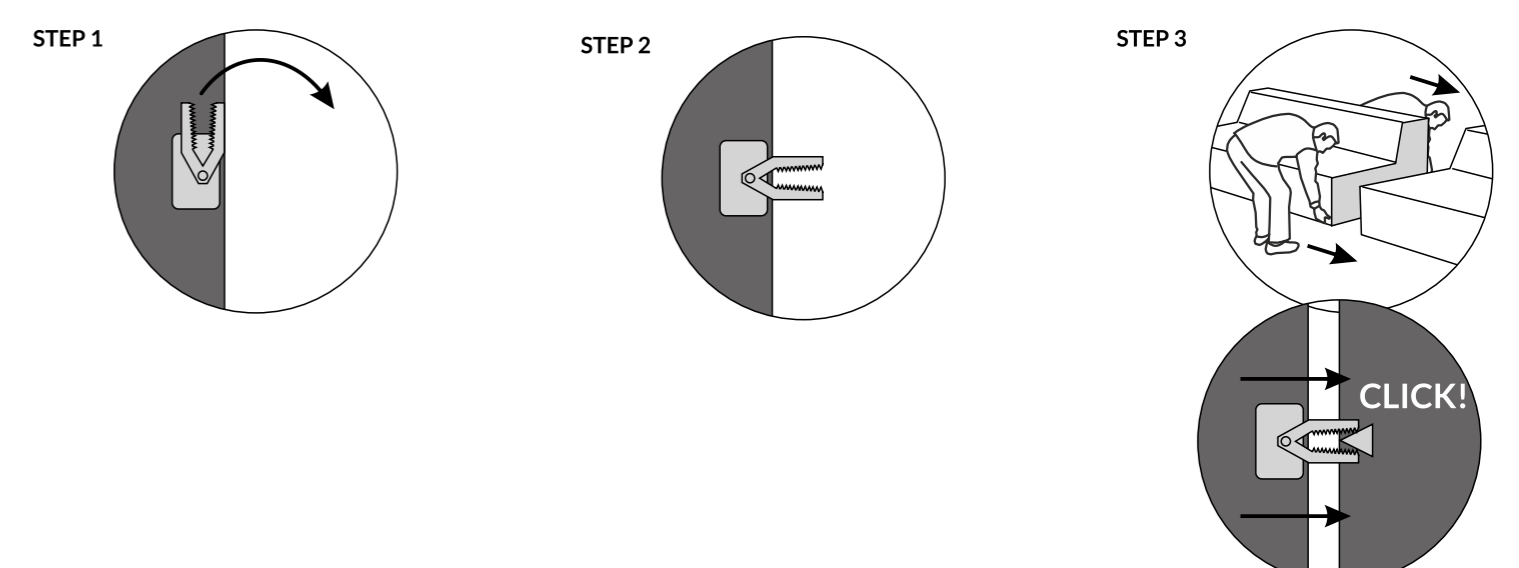
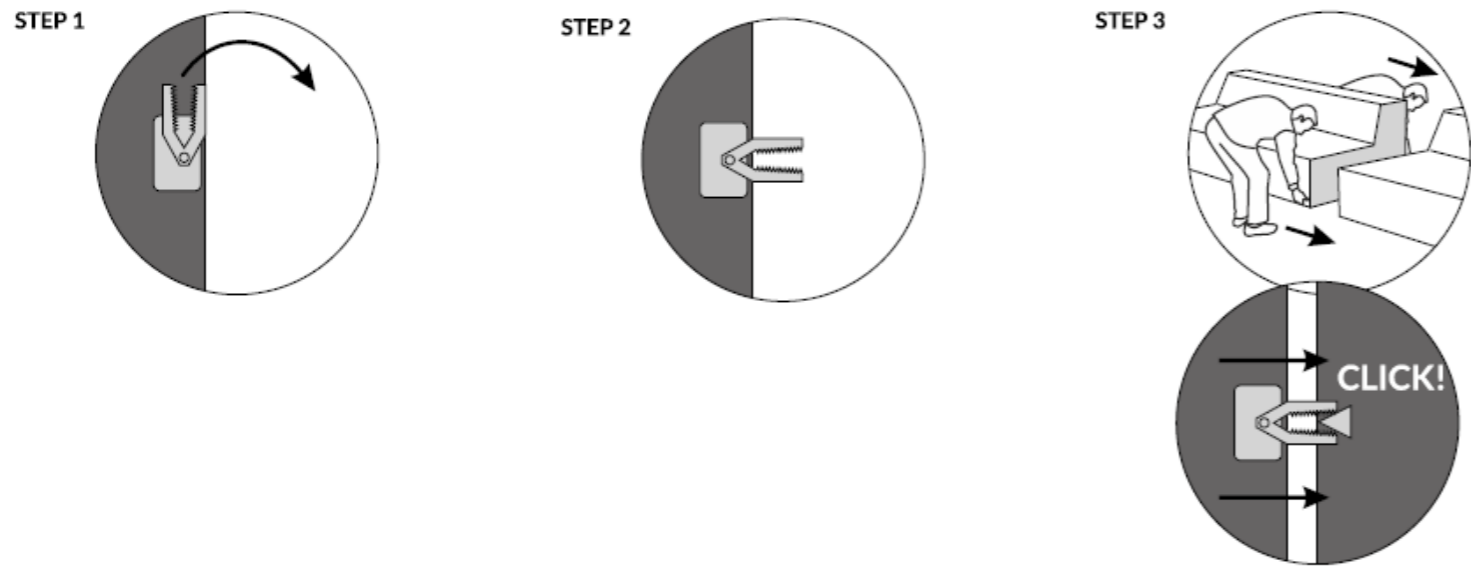
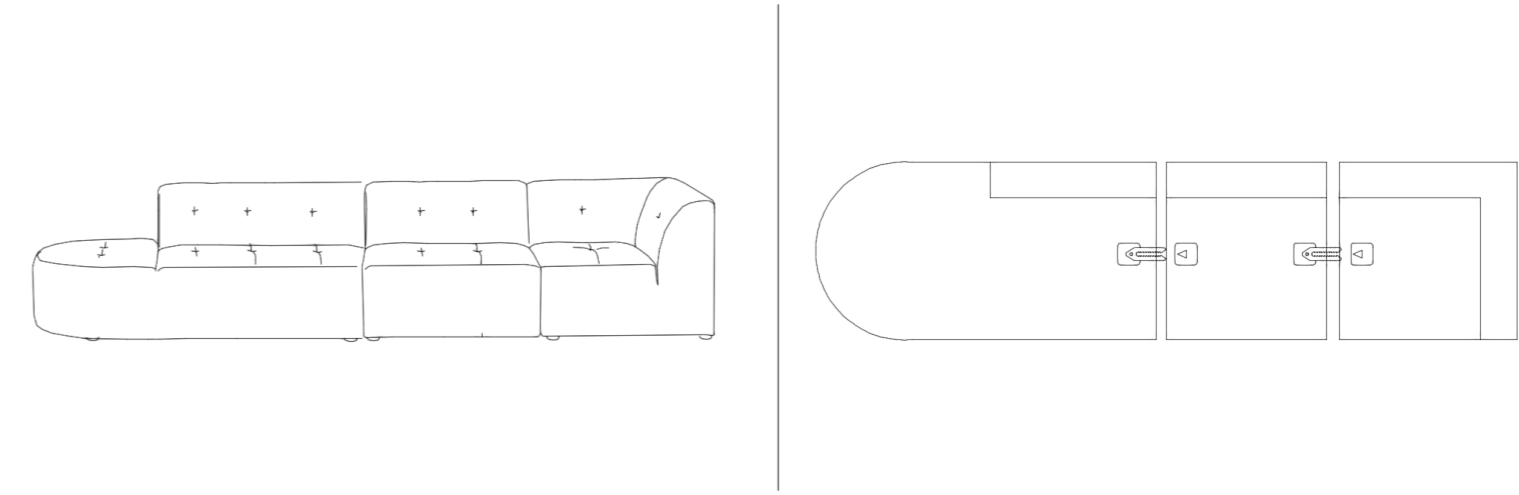
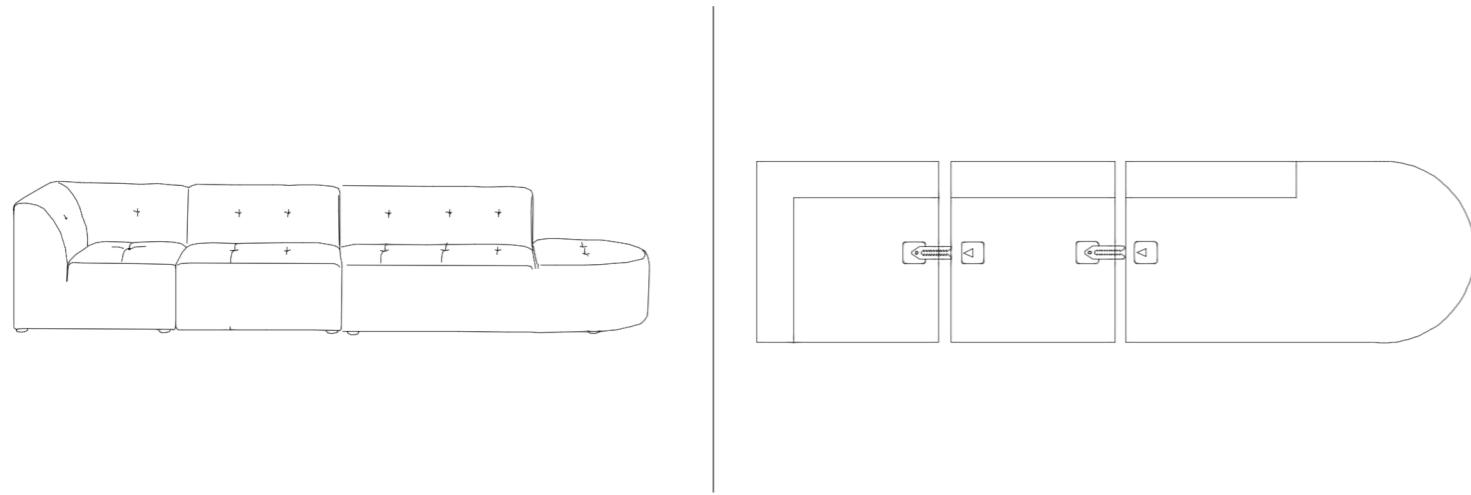

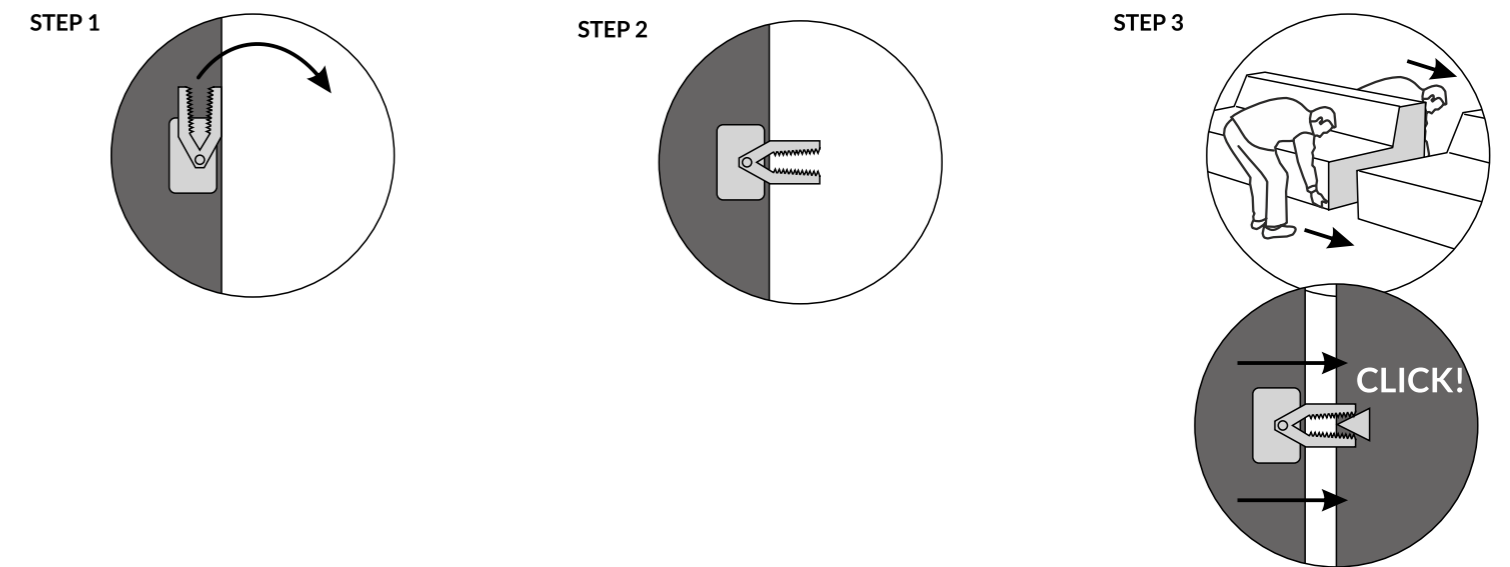
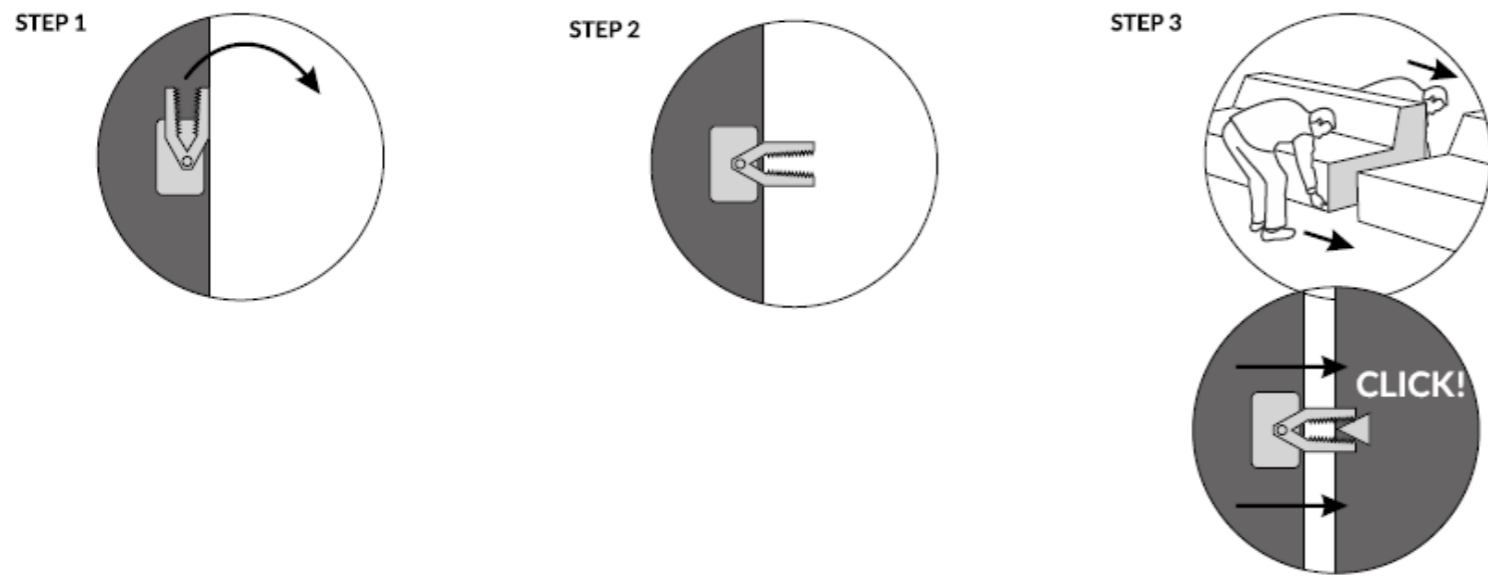
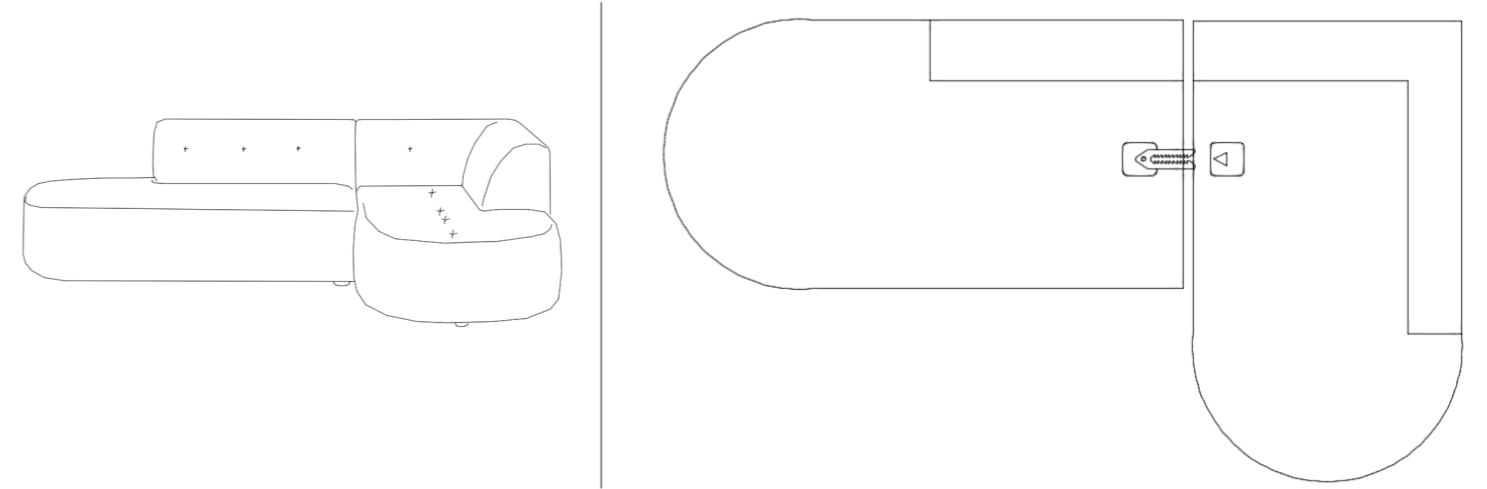
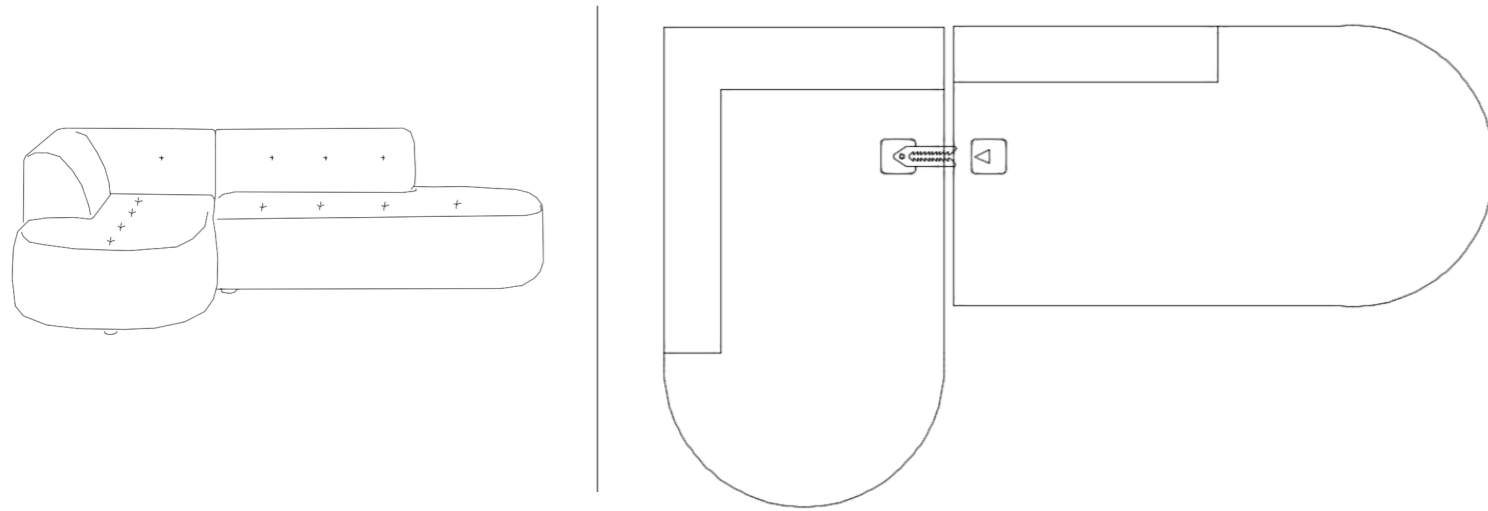

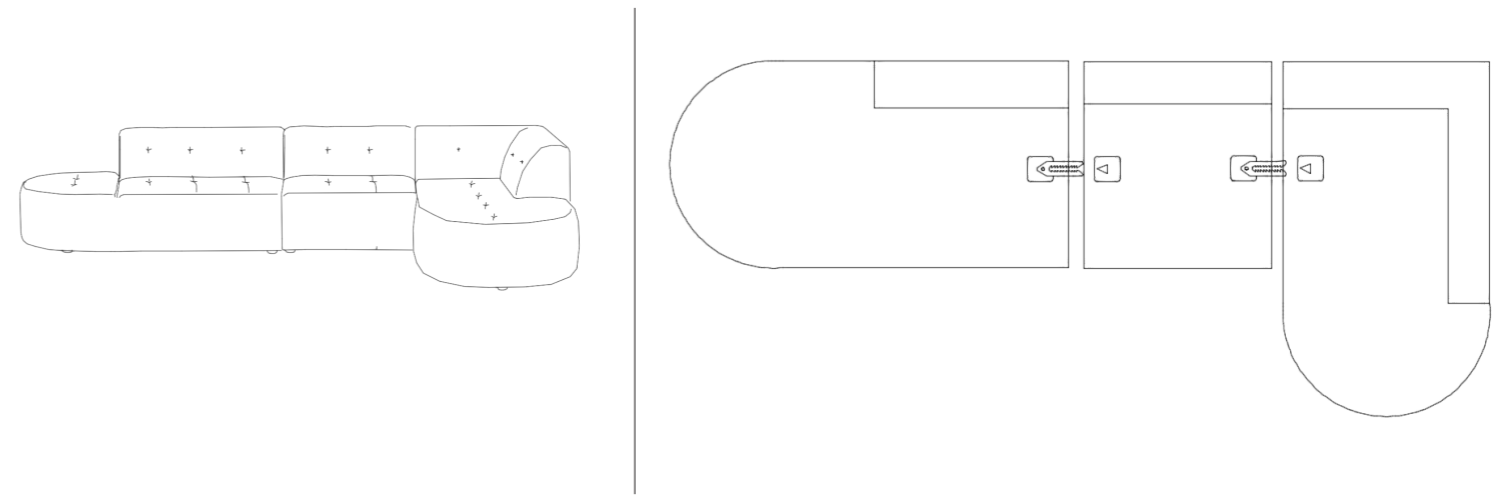
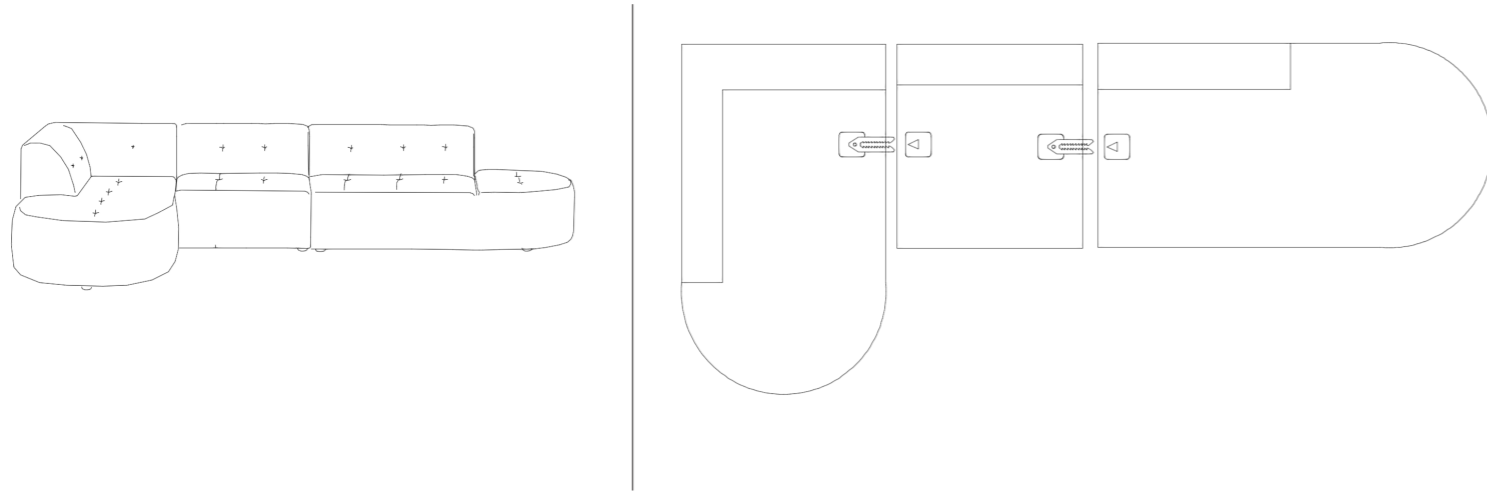

STEP 1

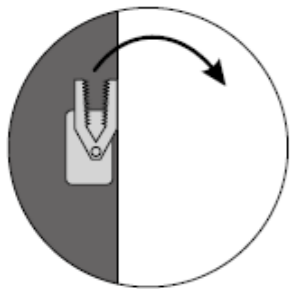

STEP 2

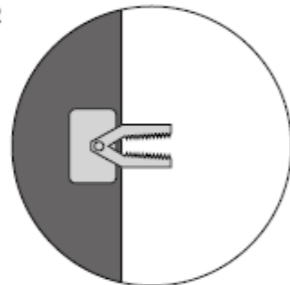

STEP 3

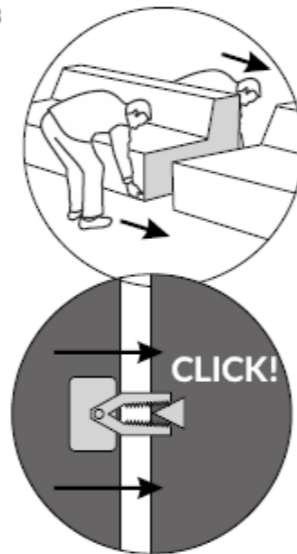

STEP 1

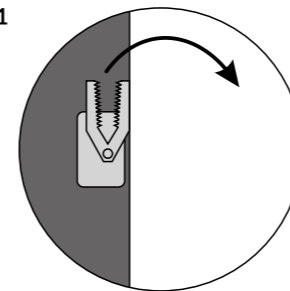

STEP 2

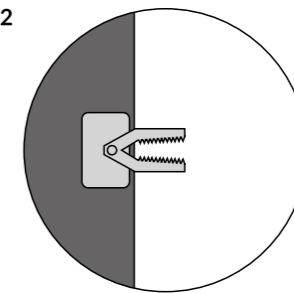

STEP 3

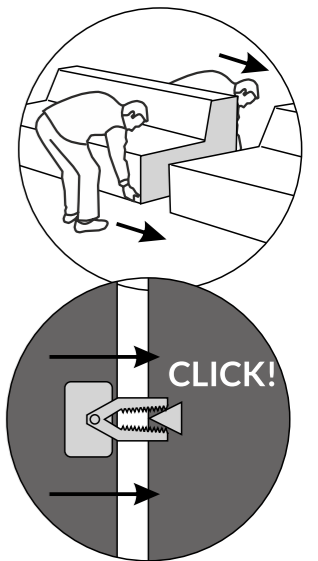

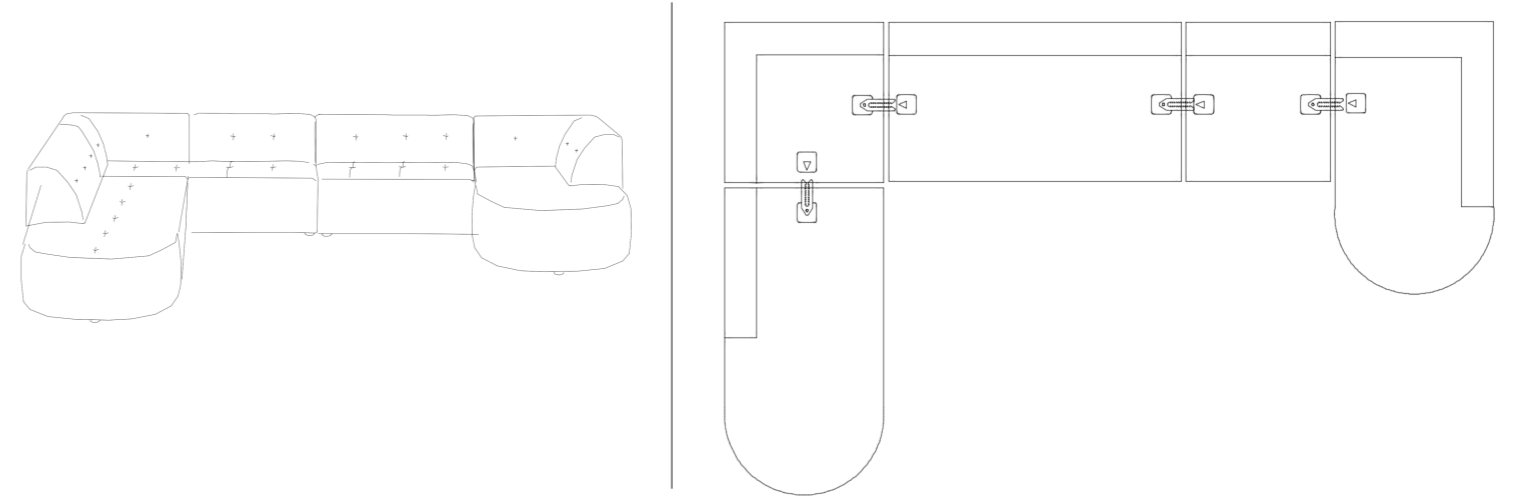
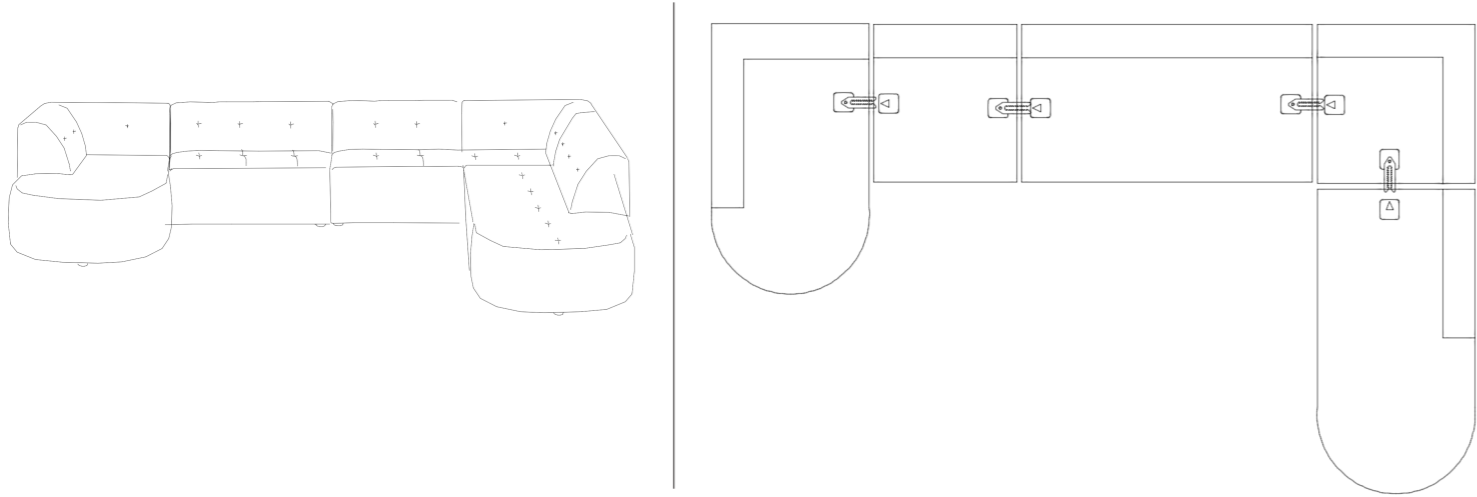

STEP 1

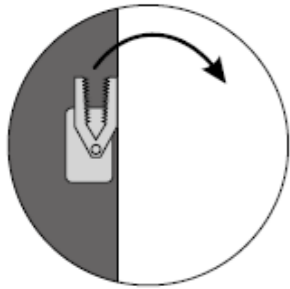

STEP 2

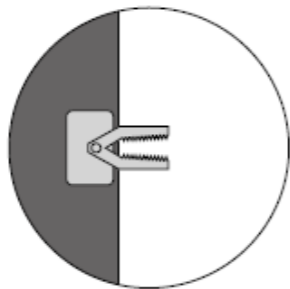

STEP 3

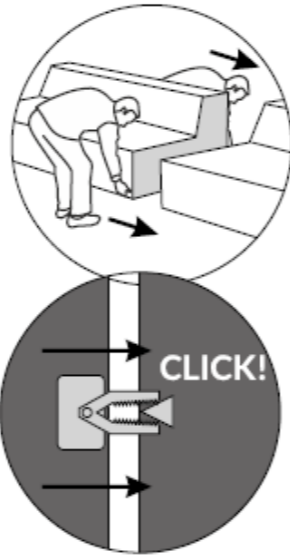

STEP 1

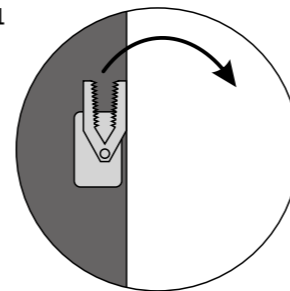

STEP 2

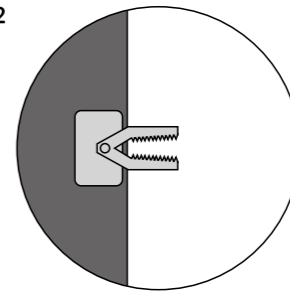

STEP 3

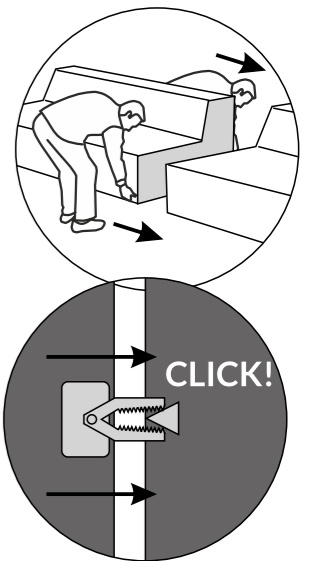

**montage tekening • assembly drawing • montagezeichnung****croquis • montaj resmini • رسم التركيب**

1. Bestudeer zorgvuldig de montagetekening voordat u met monteren begint.
2. Neem de onderdelen en panelen voorzichtig uit de verpakking en leg ze op volgorde en controleer of alles compleet is.
3. Leg het verpakkingsmateriaal ter bescherming onder het te monteren artikel.
4. Volg met het monteren exact het stappenplan zoals in de tekening aangegeven.
5. Begin met het monteren, wees voorzichtig, forceer niets.
6. Bewaar deze montagetekening zorgvuldig. U heeft deze misschien nodig in het geval u onderdelen wilt aanvragen.

1. Study the assembly drawing carefully before starting the assembly.
2. Carefully remove the parts and panels from the packing and place them in sequence. Check to see that nothing is missing.
3. For extra protection, place the packing material under the item to be assembled.
4. When assembling, follow the step-by-step instructions exactly as given on the drawing.
5. Start the assembly. Be careful not to force anything.
6. Take care to save the assembly drawing. It could be needed in case you need to order parts.

1. Studieren Sie die Montagezeichnung gut, bevor Sie mit der Montage beginnen.
2. Nehmen Sie die Zubehörteile und Paneelen vorsichtig aus der Verpackung, legen Sie sie in die richtige Reihenfolge und kontrollieren Sie, ob alles komplett ist.
3. Legen Sie das Verpackungsmaterial zum Schutz unter den zu montierenden Artikel.
4. Folgen Sie bei der Montage genau dem Schritteplan, wie er in der Zeichnung angegeben ist.
5. Beginnen Sie mit der Montage, seien Sie vorsichtig, übereilen Sie nichts.
6. Bewahren Sie diese Montagezeichnung gut auf. Sie benötigen diese möglicherweise zur Bestellung von Zubehörteilen.

1. Examinez soigneusement le croquis avant de procéder au montage.
2. Sortez soigneusement les pièces et les panneaux de leur emballage, placez-les dans l'ordre et assurez-vous que rien ne manque.
3. Placez le matériel d'emballage protecteur sous l'article à monter.
4. Suivez scrupuleusement les étapes de montage comme indiqué sur le croquis.
5. Commencez le montage. Soyez prudent et ne forcez pas.
6. Conservez soigneusement le croquis de montage. Vous en aurez peut-être besoin lorsque vous souhaitez remplacer un élément.

1. Montaj i?ine ba?lamadan önce montaj resmini dikkatle inceleyiniz.
2. Parçaları ve panoları ambalajından özenle çıkartınız, sıraya koyunuz ve her?eyin tam olup olmadığını kontrol ediniz.
3. Monte edilecek nesnenin altına, koruma amacıyla ambalaj malzemesi seriniz.
4. Montaj sırasında resimde belirtildi?i gibi safha planını takip ediniz.
5. Montaja ba?layınız, dikkatli olunuz ve hiç bir parçayı zorlamayınız.
6. Bu montaj resmini iyice saklayınız. ?leride parça ihtiyacı sırasında gerekli olabilir.

- 1) يجب النظر في رسم التركيب بدقة قبل الشروع في عملية التركيب.
- 2) يجب أخذ الأقسام والألواح من العلبة بحذر ووضعها حسب ترتيب كما يجب التأكد من وجود جميع الأقسام.
- 3) ضع مواد التغليف تحت السلعة المقرر تركيبها وذلك للحماية.
- 4) يجب متابعة المراحل الموصوفة في رسم التركيب خطوة خطوة.
- 5) أبدأ عملية التركيب, يجب القيام بذلك بحذر, لا تربط شيئاً بشدة حتى لا تخسر شيئاً.
- 6) يجب حفظ هذا الرسم. إذا أردت طلب أقسام احتياطية قد تحتاجه.