

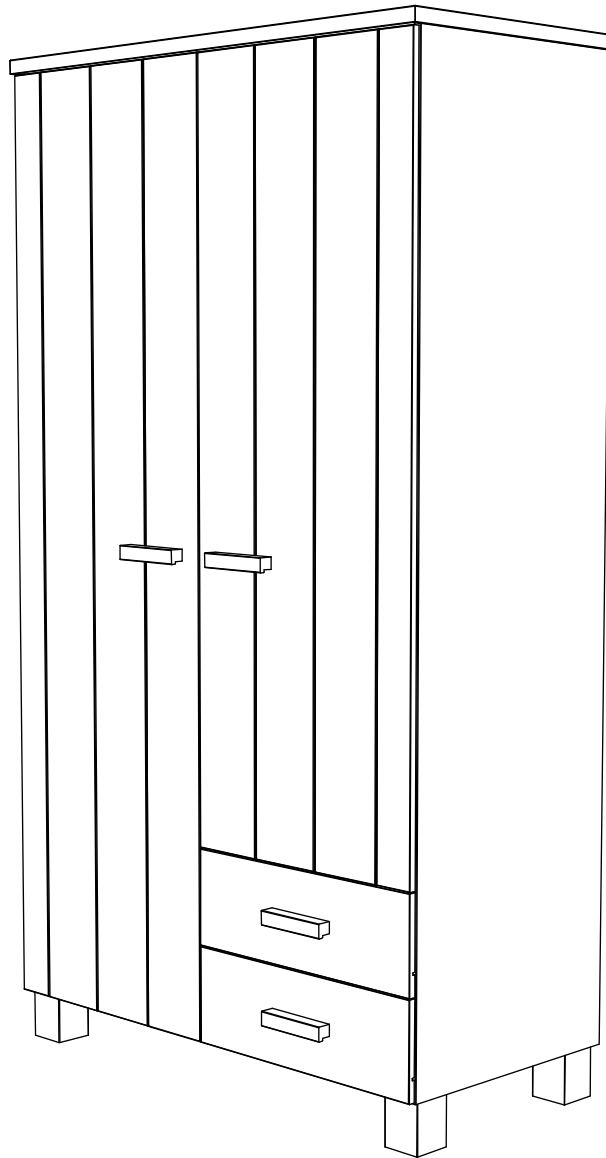

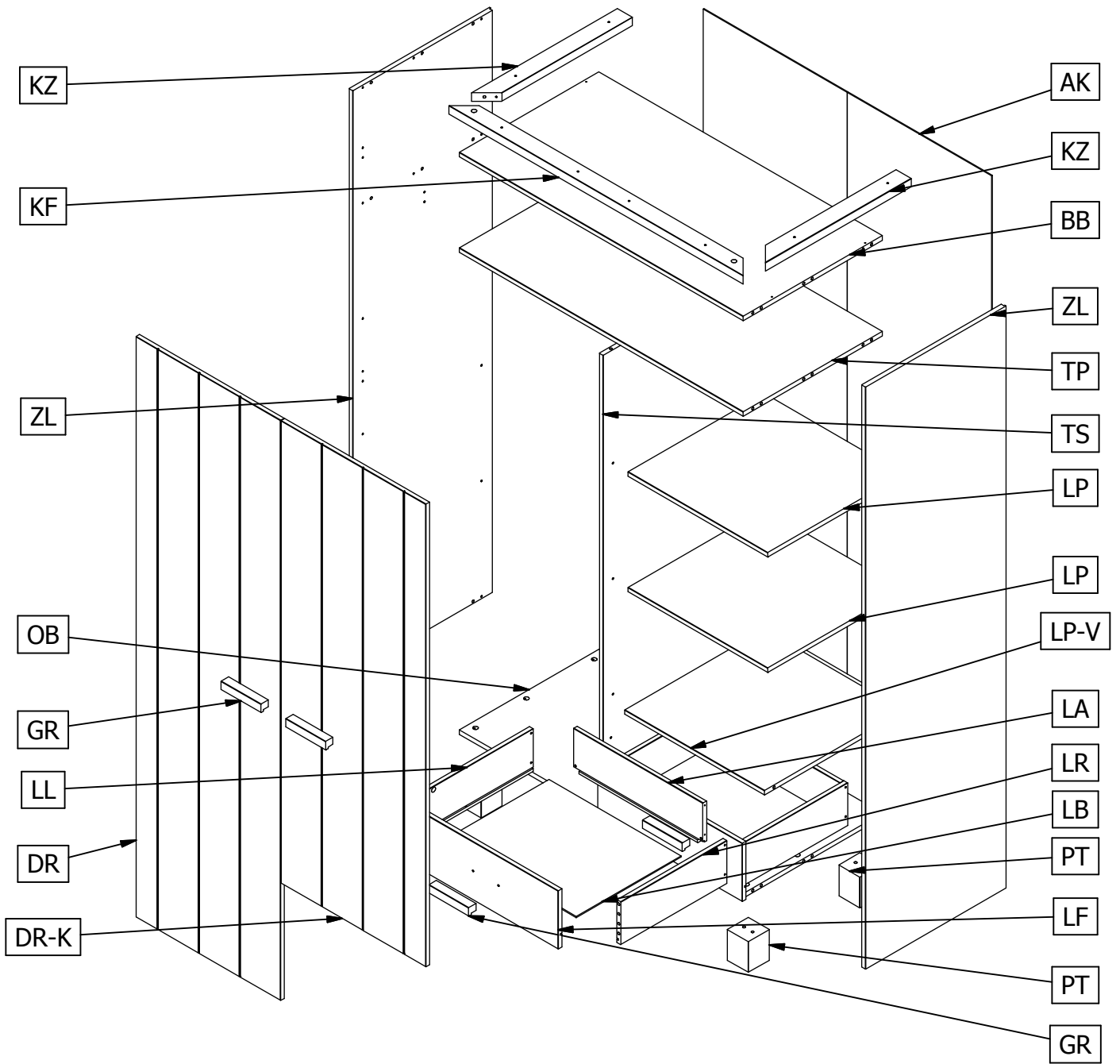







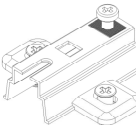

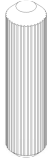

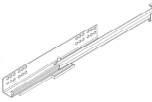

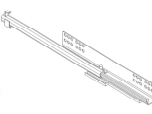
DENNIS KAST MET LADEN

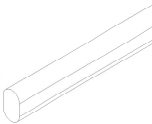
SCHRANK - ARMOIRE - WARDROBE

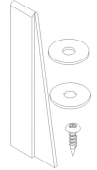

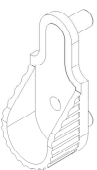

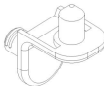
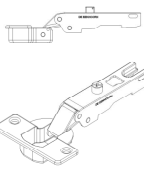
36	Ø15mm	AC000102 	6	2MM	AC000448 
36	24mm	AC000103 	28	8x35mm	AC000601 
8	3.5x40mm	AC000203 	2	L=400	AC00823-L 
14	4x16mm	AC000204 	2	L=400	AC00823-R 
34	3.5x35mm	AC000219 	1	L=520	AC000902 
8	7x6.3x9mm	AC000247 	1	Safety balanc	AC000356 
50	Ø1.4x25mm	AC000316 	28	Ø14	AC000369-* 
2	15x22mm	AC000335 	1	Gleu	AC000607 
8	Ø5Mmm	AC000349 			
6	35mm 0V	AC000423 			

1

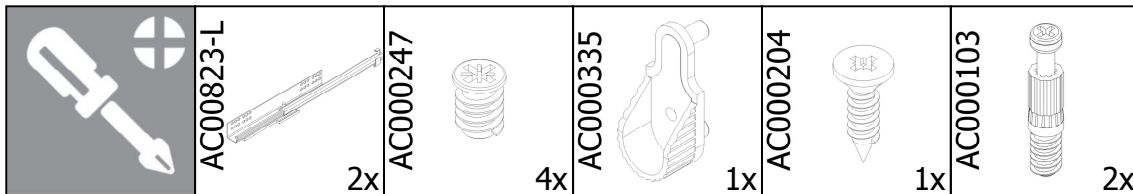

AC000335

AC000204

TS

AC000103

AC000823-L

AC000823-L

AC000247

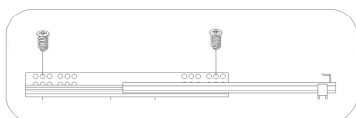

2

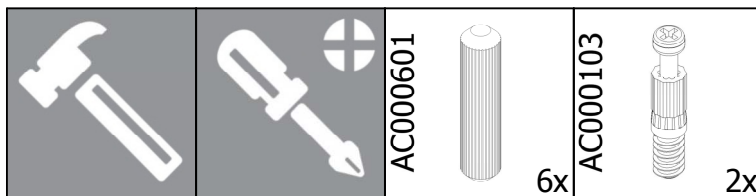

AC000601

AC000103

TP

3

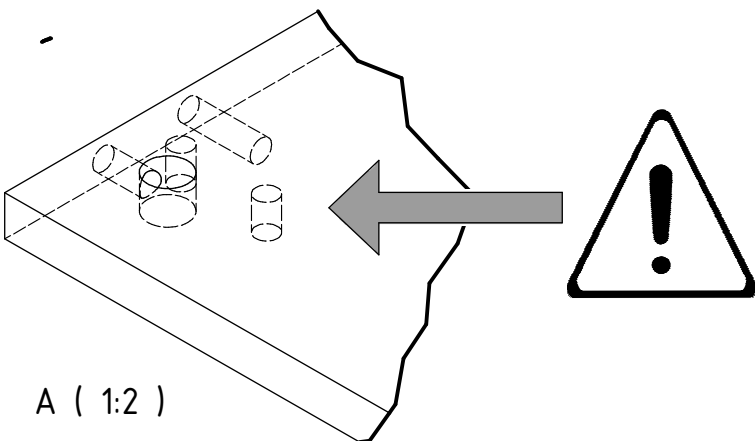
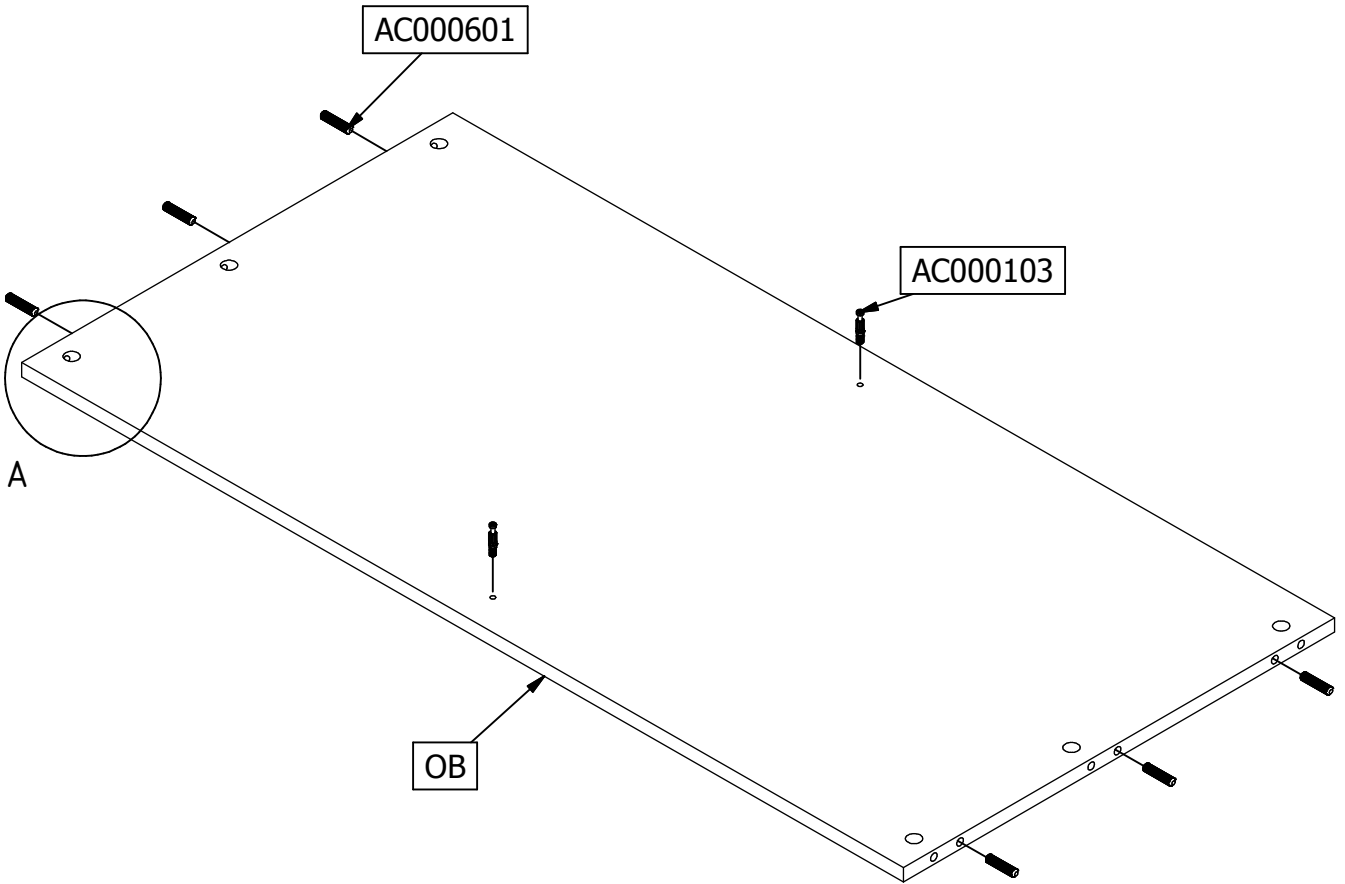
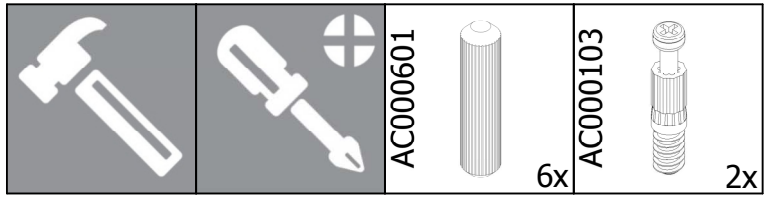

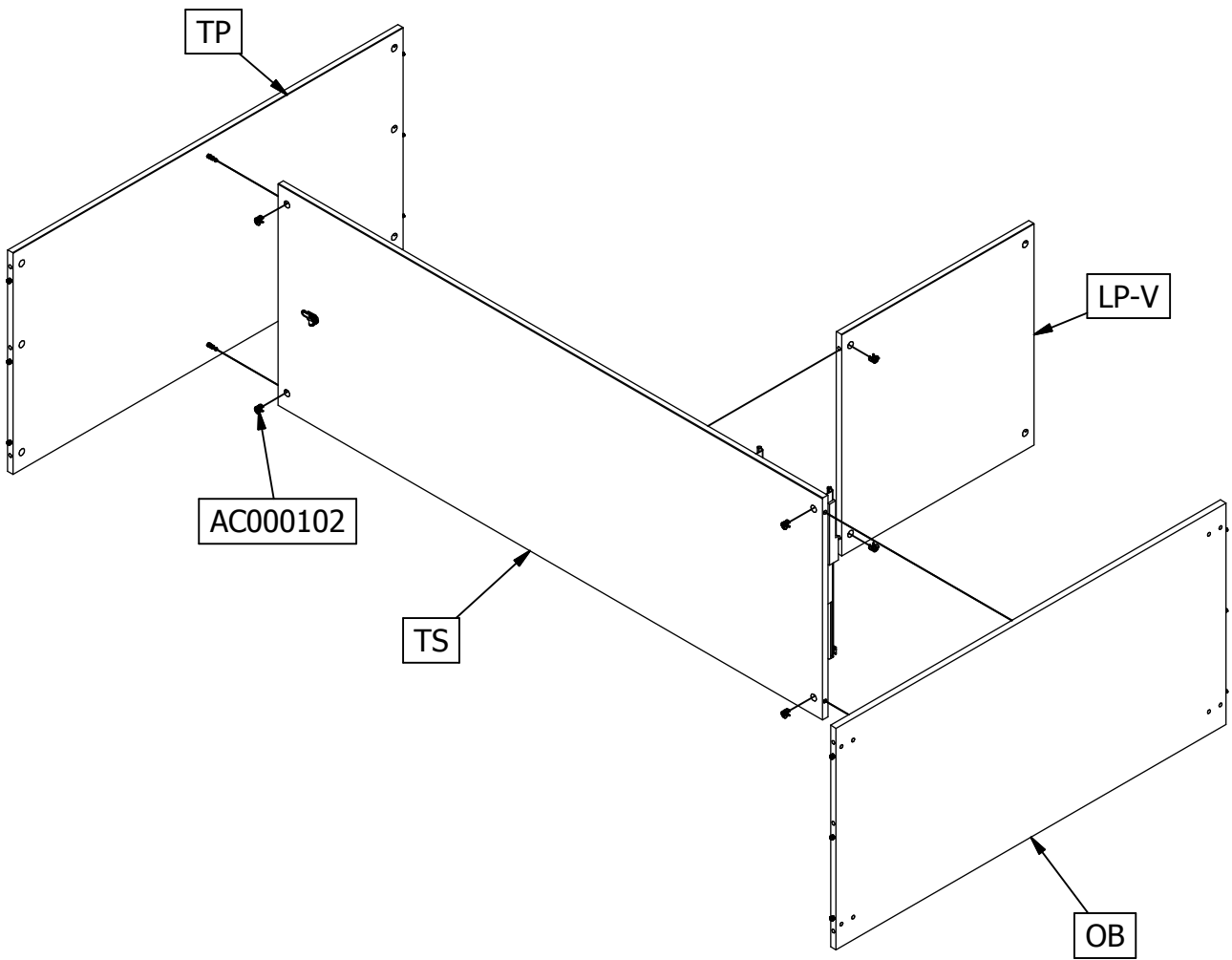
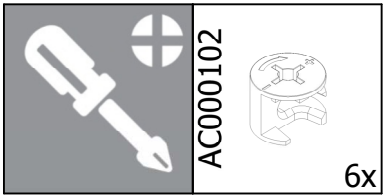



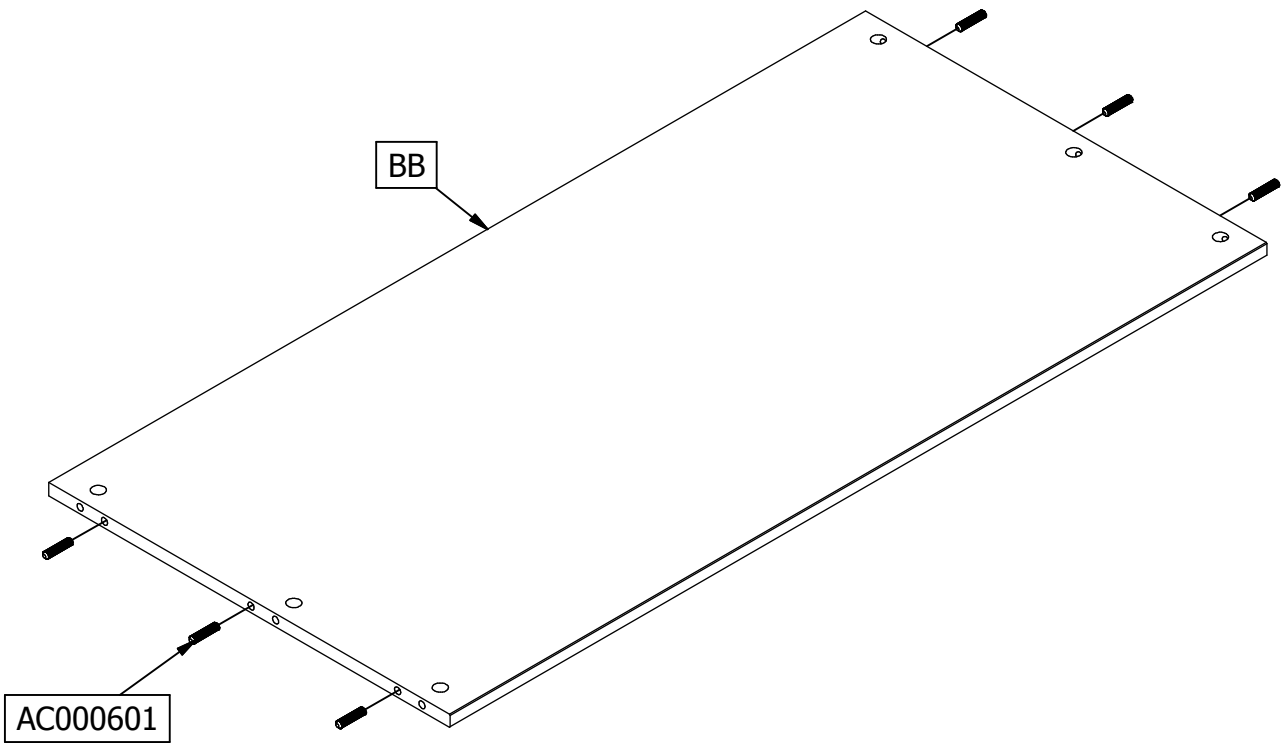
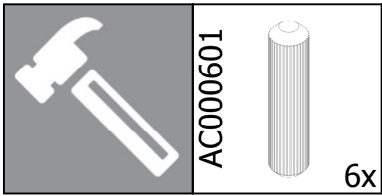

5

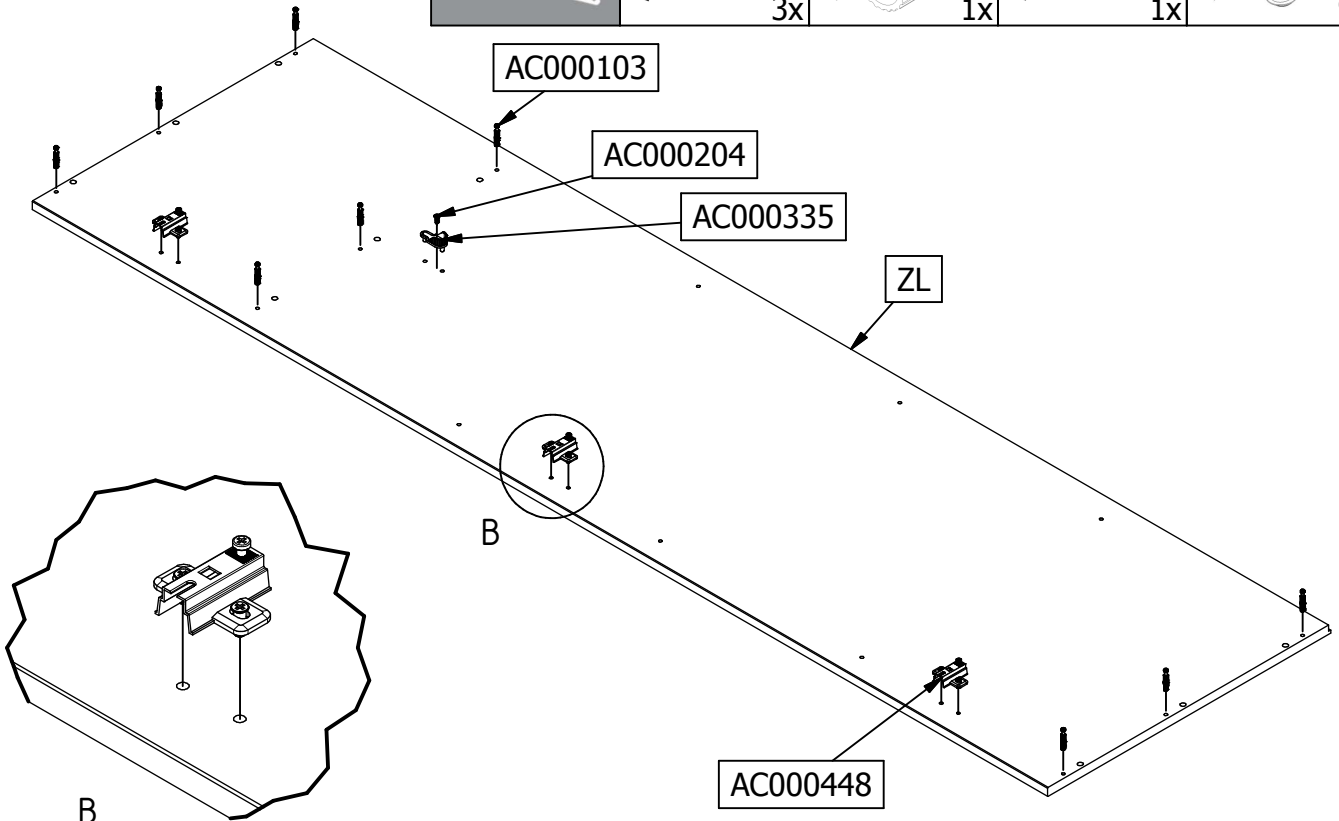
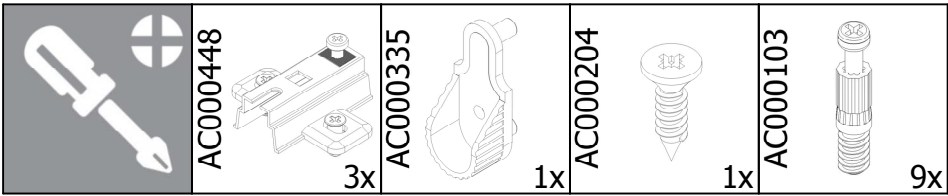

6

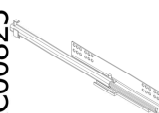

7

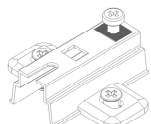
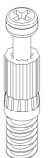
	AC00823-R  2x	AC000247  4x	AC000448  3x	AC000103  11x
---	--	--	---	--

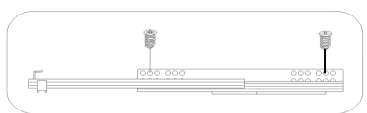
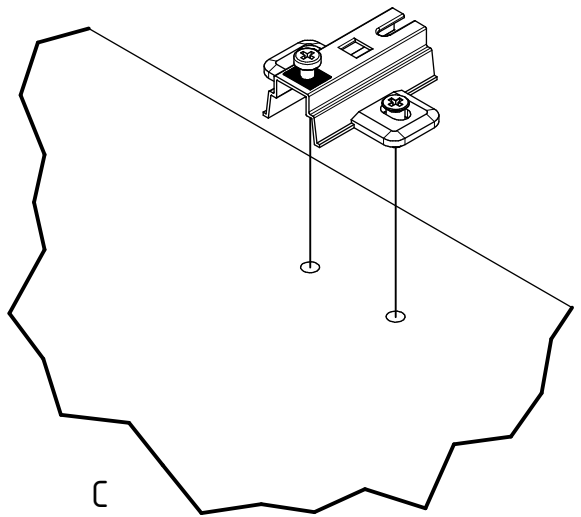
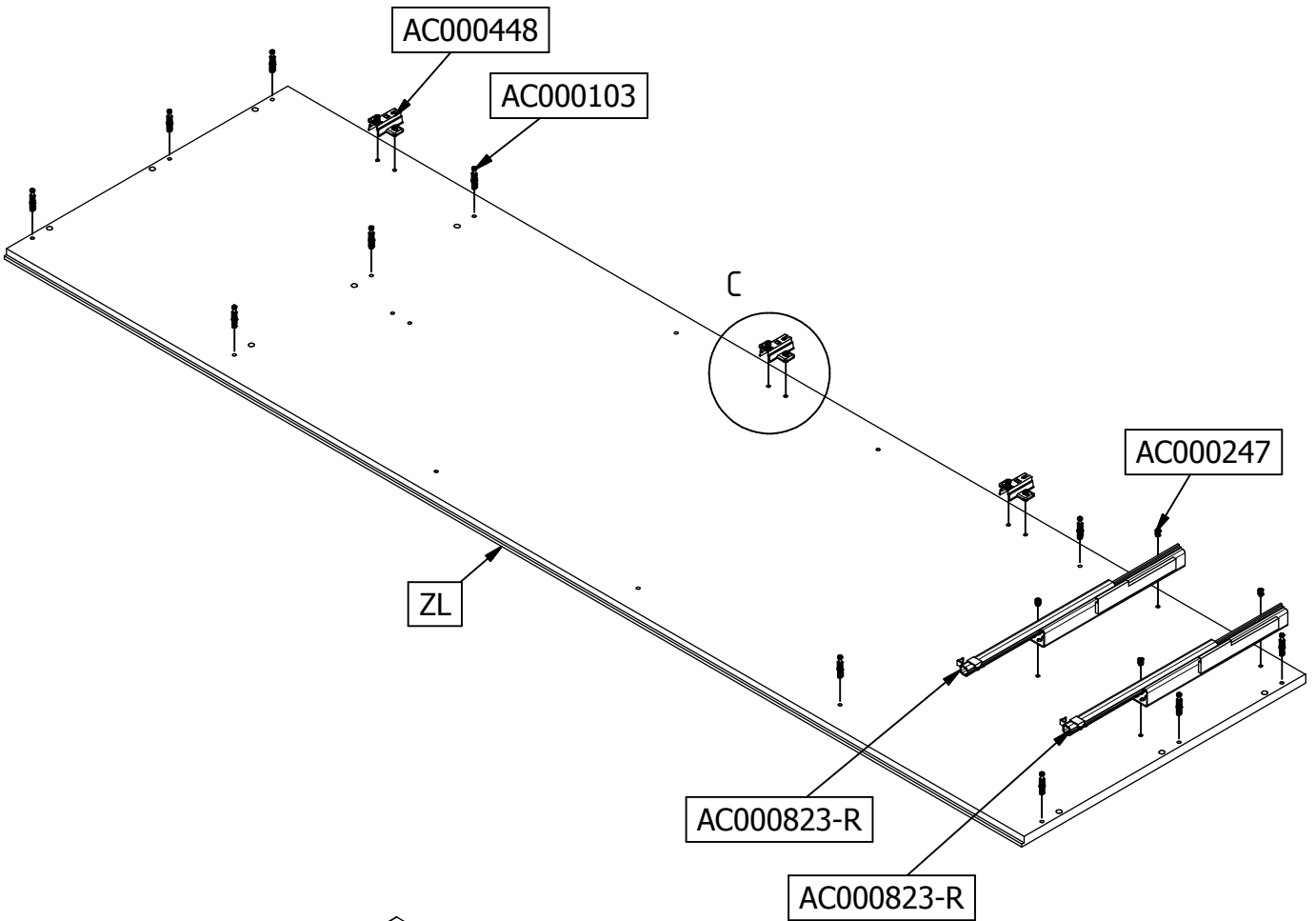

		AC000102	
--	--	----------	--

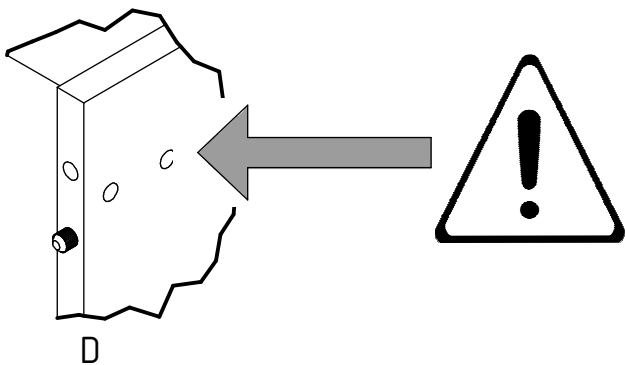
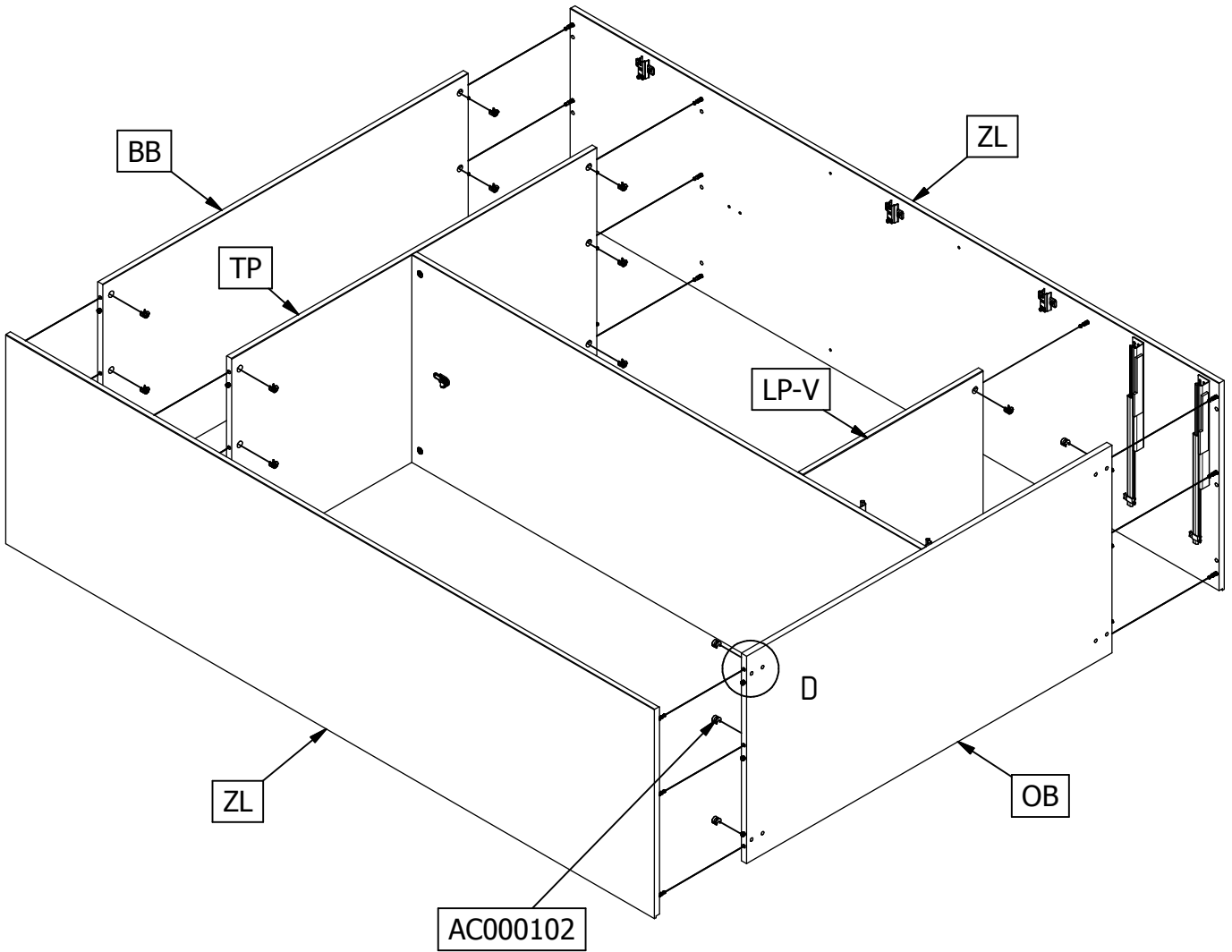

9

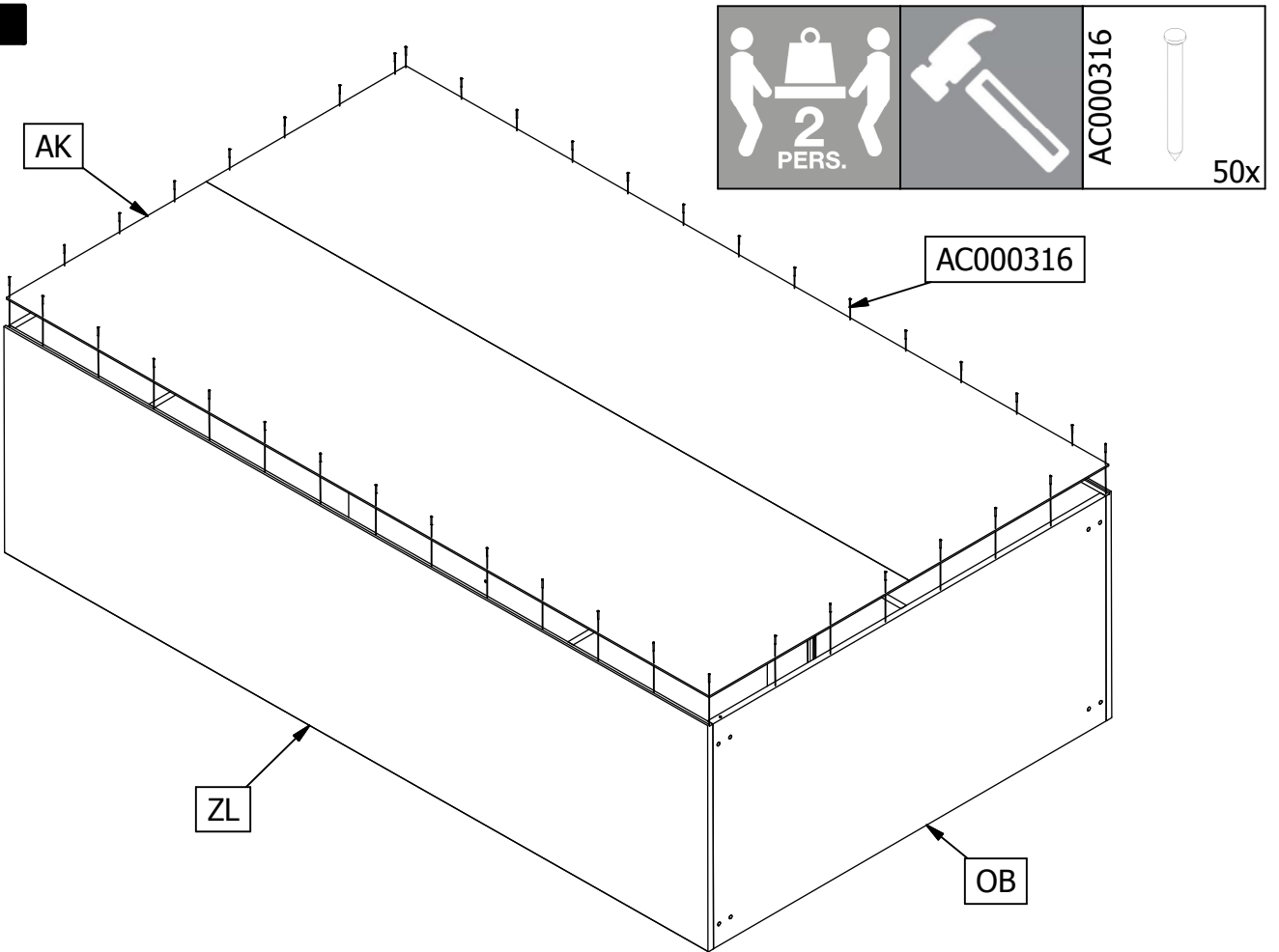

10

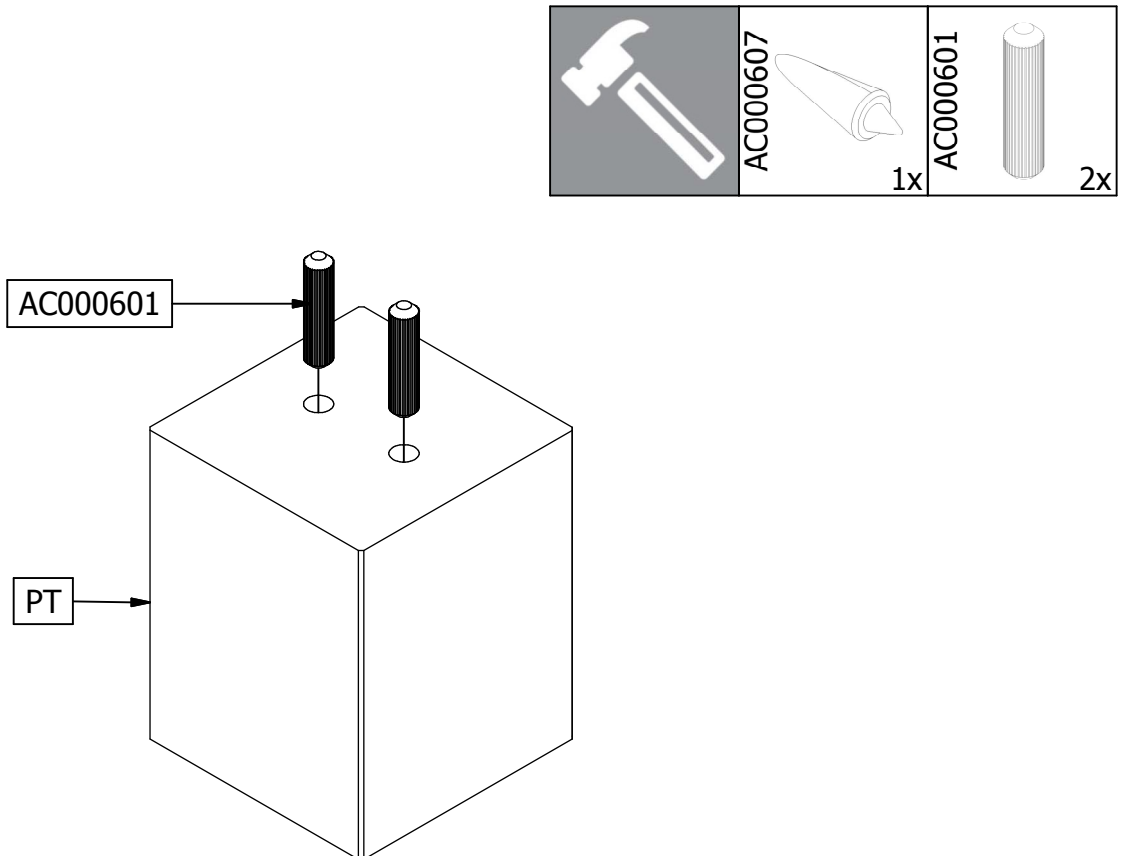

4x

Het gebruik van een klein beetje houtlijm is noodzakelijk voor een goede verbinding
 Für eine stabile Verbindung ist ein bisschen Holzleim erforderlich
 Un peu de colle à bois est nécessaire pour un assemblage solide
 The use of a little wood glue is necessary for proper connection

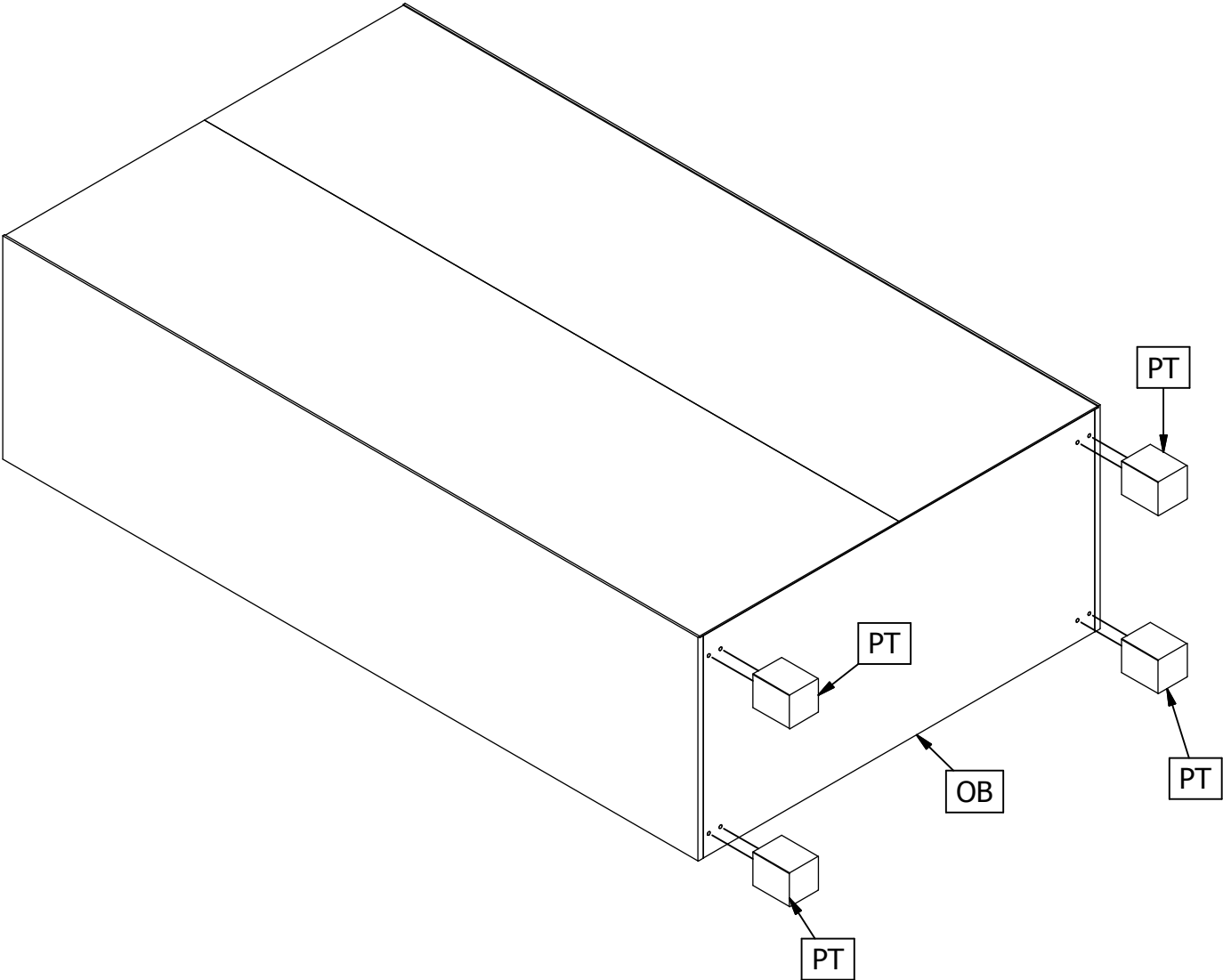
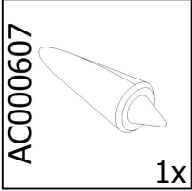

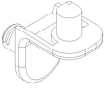
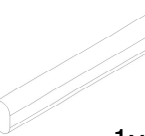

Het gebruik van een klein beetje houtlijm is noodzakelijk voor een goede verbinding
Für eine stabile Verbindung ist ein bisschen Holzleim erforderlich
Un peu de colle à bois est nécessaire pour un assemblage solide
The use of a little wood glue is necessary for proper connection

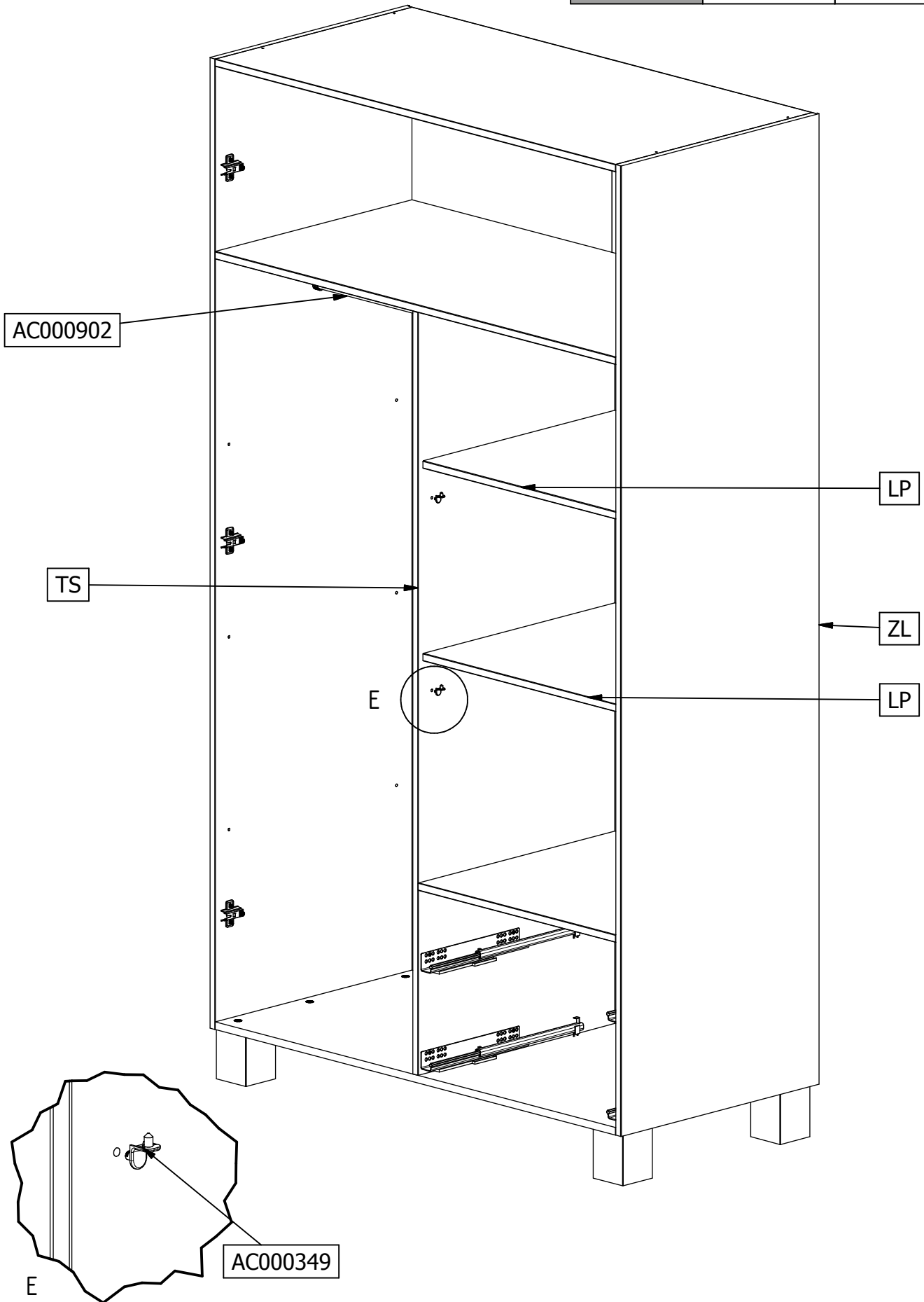
 2 PERS.	AC000349	 8x	AC000902	 1x
--	----------	---	----------	---





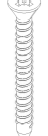

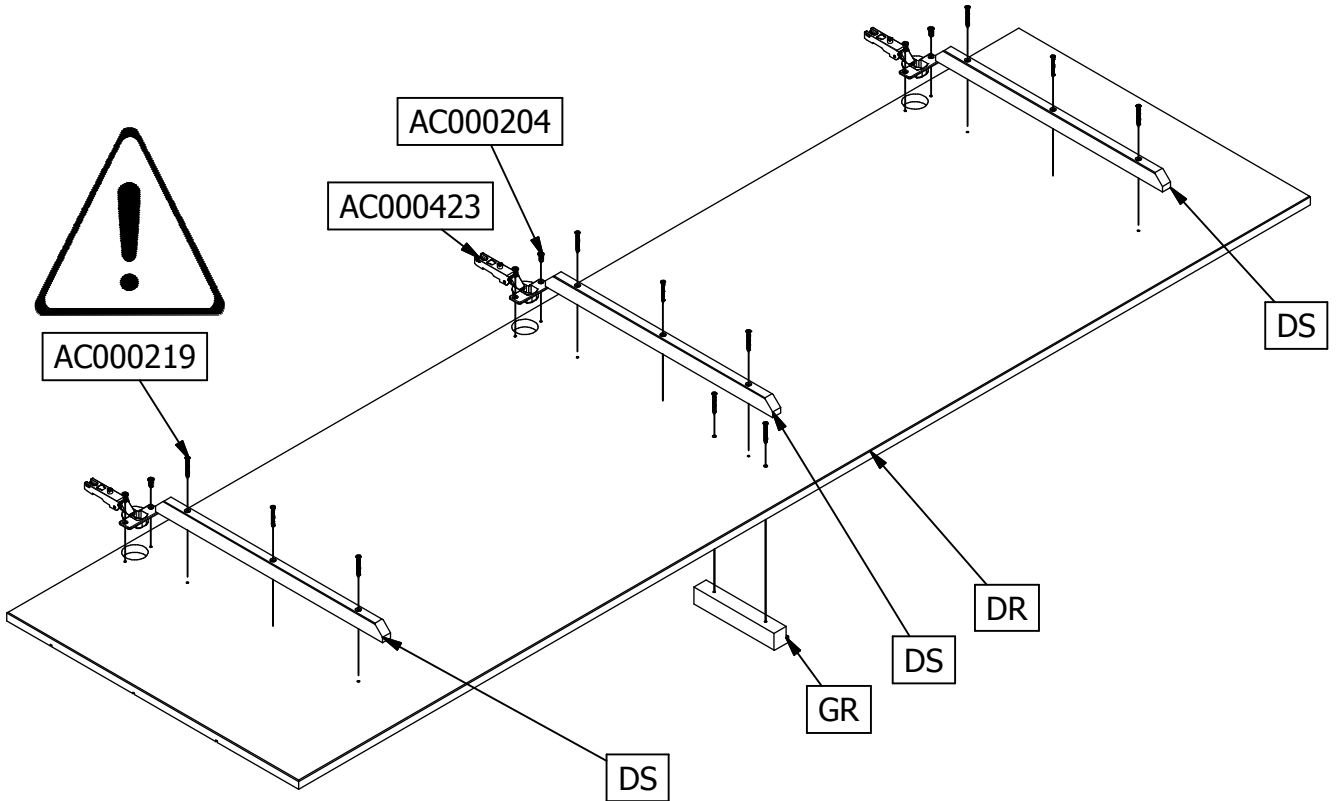
13

			
	AC000423 3x	AC000204 6x	AC000219 11x



14

			
	AC000423 3x	AC000204 6x	AC000219 11x

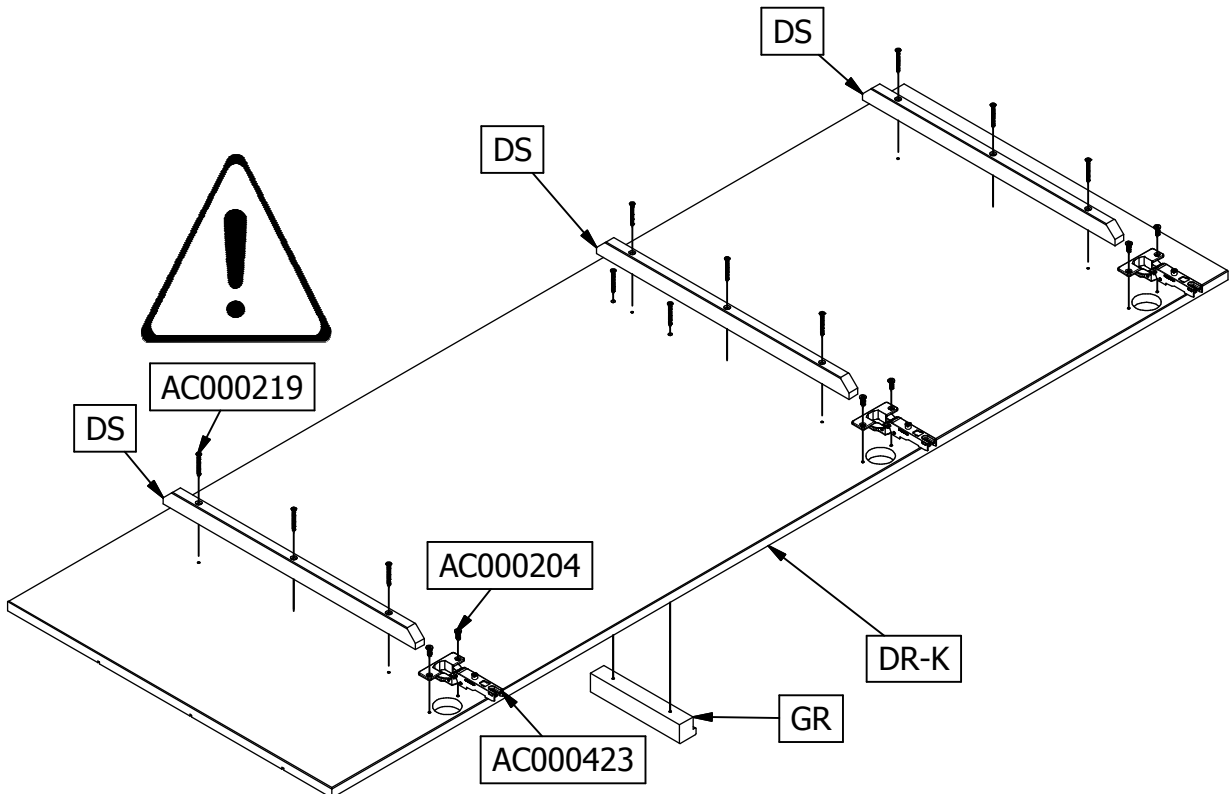

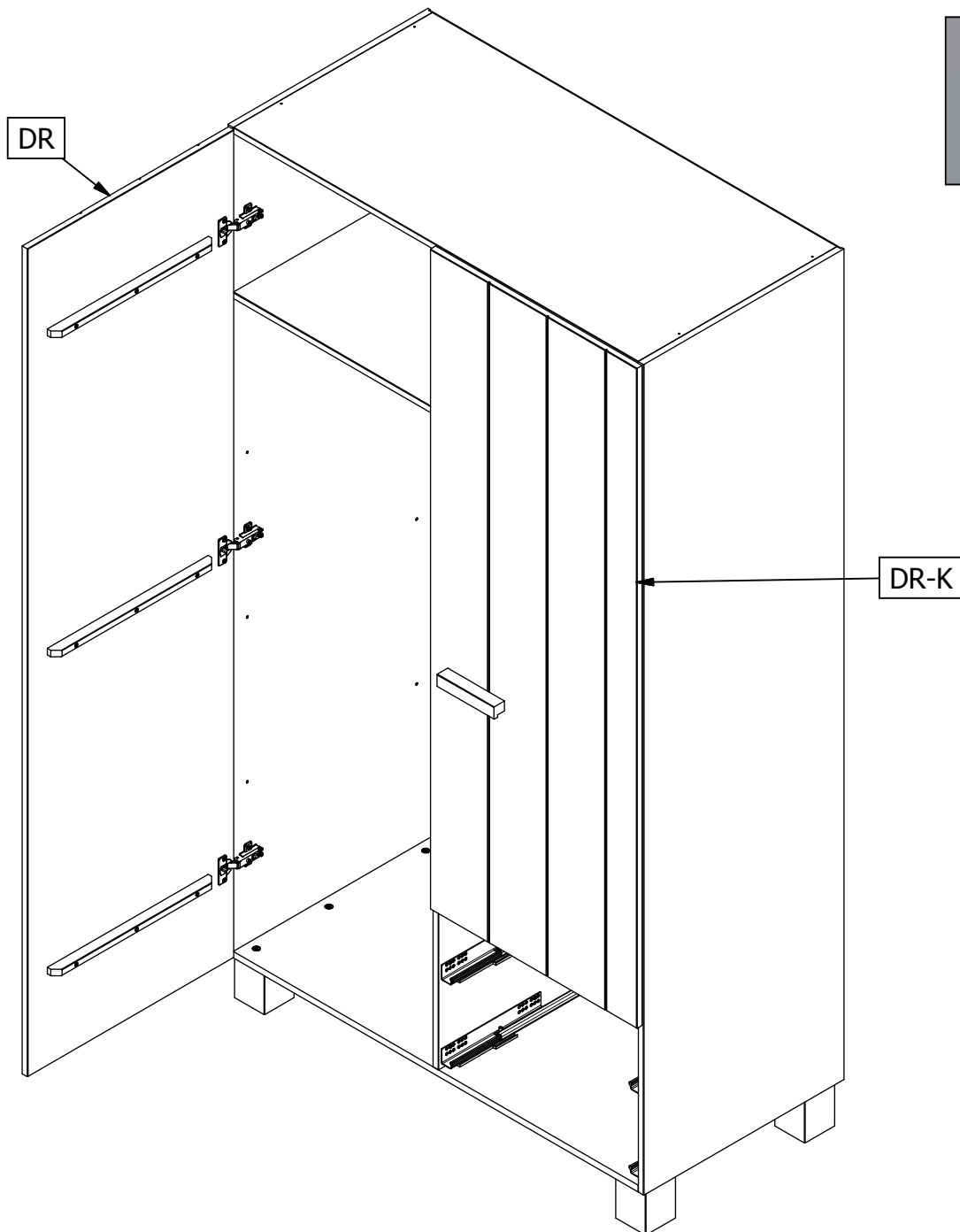

- A. Deze schroef gebruiken wanneer u de kieren tussen de deuren en beide zijden groter of kleiner wilt hebben.
 B. Door deze schroeven iets los te draaien kunt u de scharnierplaatjes verstellen zodat de deuren hoger of lager bevestigd kunnen worden.
 C. Met deze schroef draait u de deur vast.

- A. Diese Schraube benutzen, wenn der Spalt zwischen der Tür und den Seiten größer oder kleiner sein soll.
 B. Wenn Sie diese Schrauben ein wenig lösen, können Sie die Scharnierplatten verstellen, um so die Tür höher oder niedriger zu befestigen.
 C. Mit dieser Schraube befestigen Sie die Tür.

- A. Utilisez cette vis, si vous voulez agrandir ou réduire la fente entre la porte et les deux côtés de l'armoire.
 B. En dévissant ces vis quelque peu, vous pouvez régler les charnières pour accrocher ensuite la porte plus haute ou plus basse.
 C. Fixez la porte à l'aide de cette vis.

- A. Adjusting this screw will position doors horizontally (changes gap between doors)
 B. By releasing this screw the position of mounting plates of the hinges can be repositioned so that vertical position of doors can be adjusted (higher/lower)
 C. This screw fixes the door.

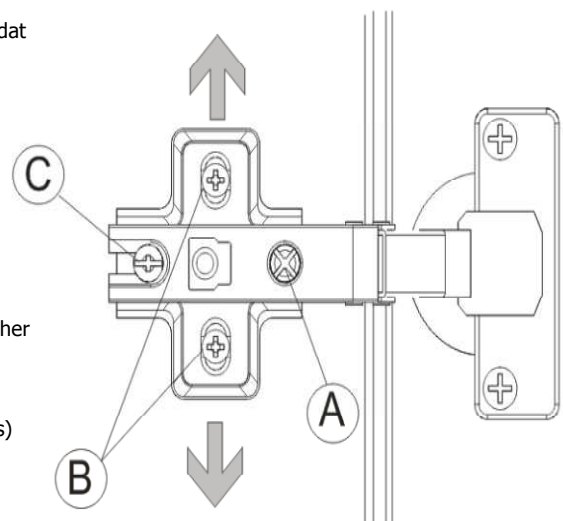

16

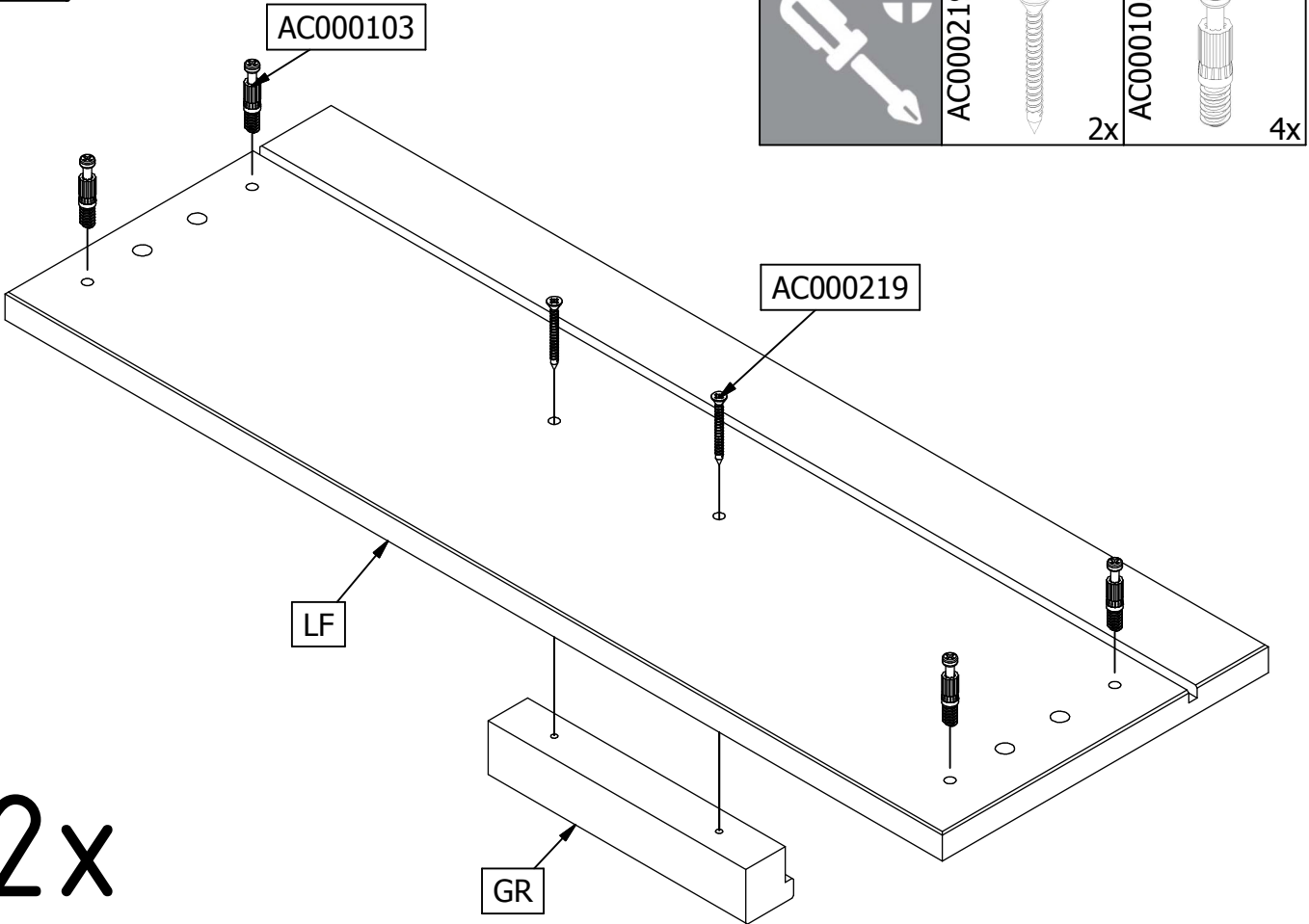

2x

17

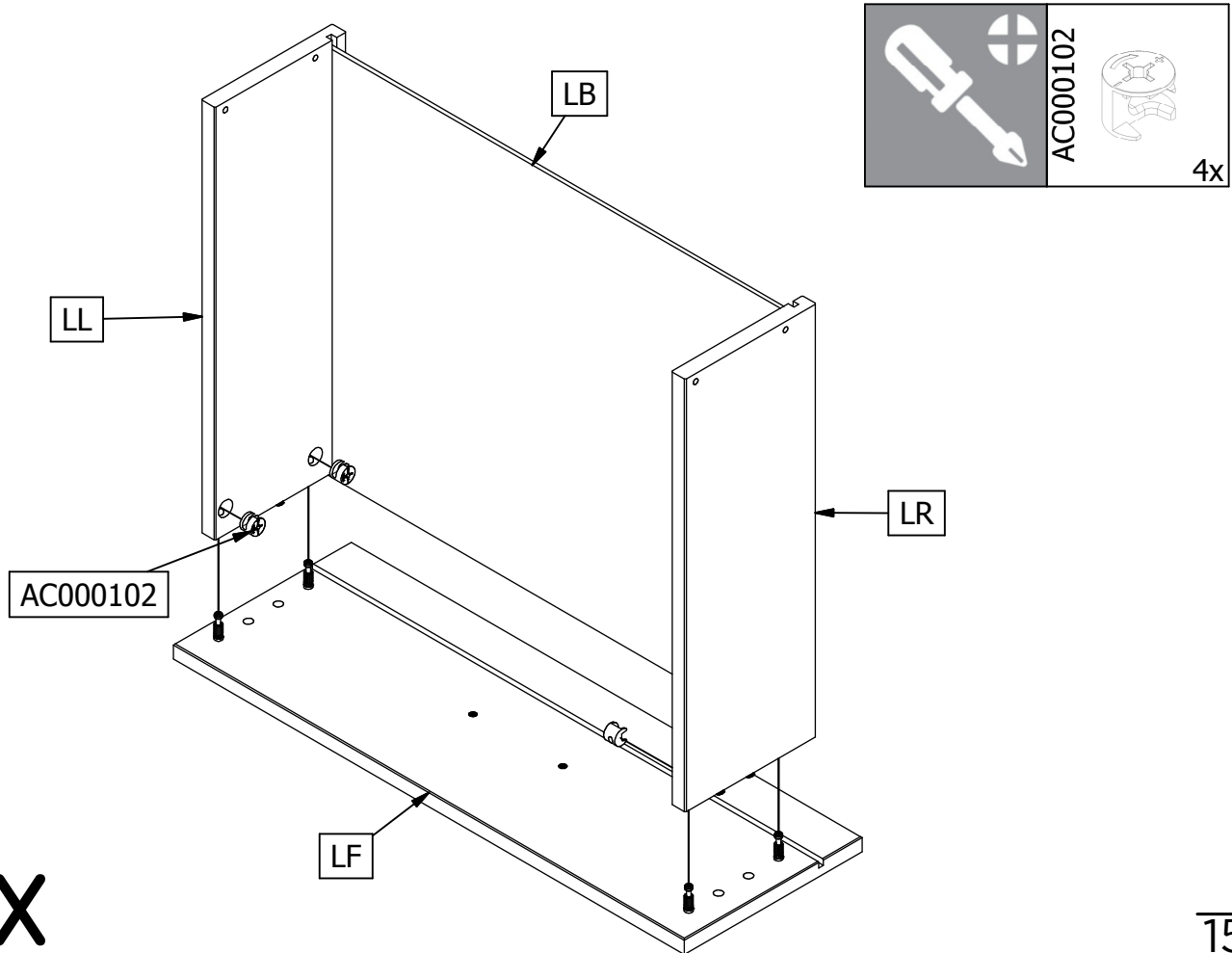

2x

18

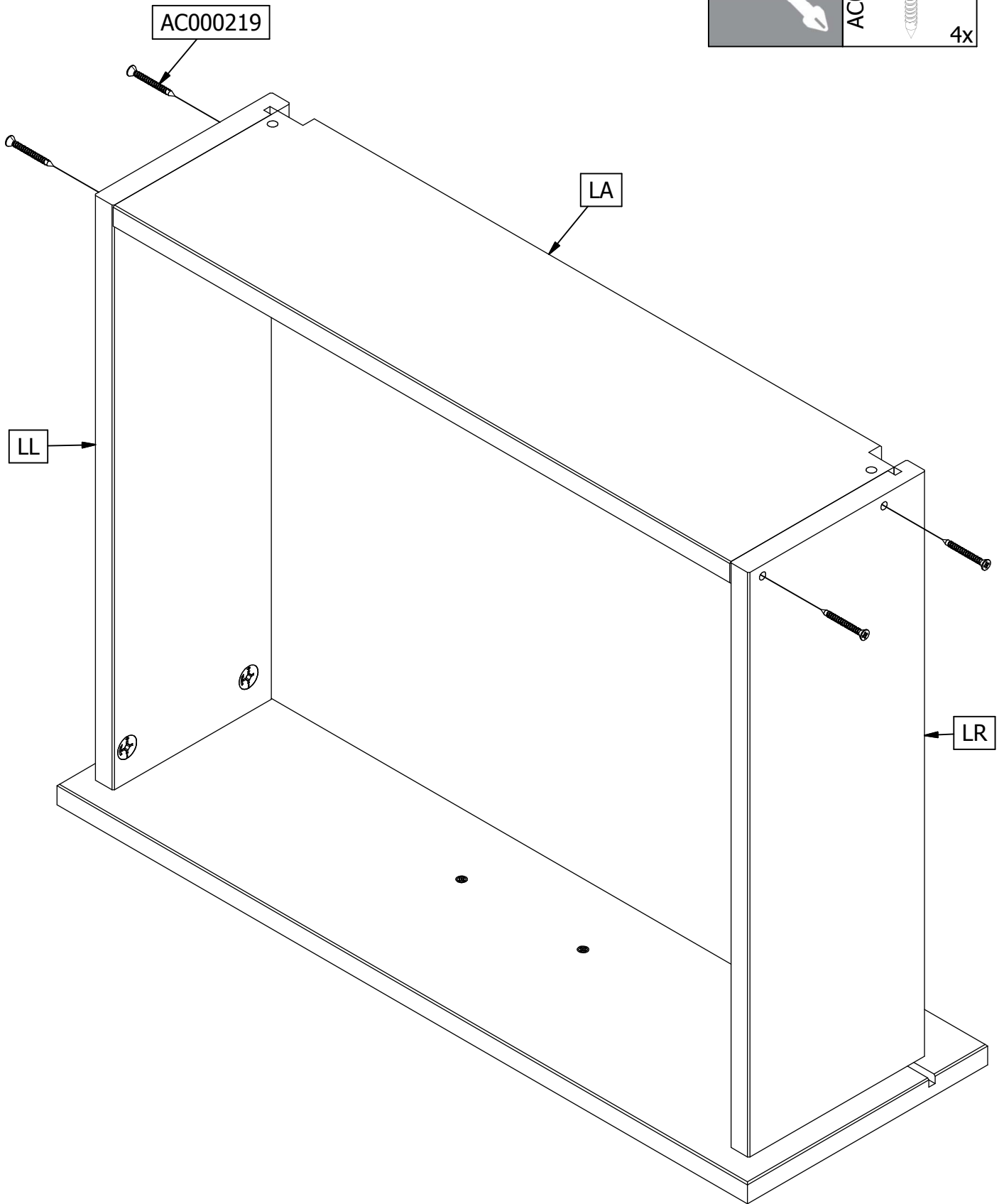
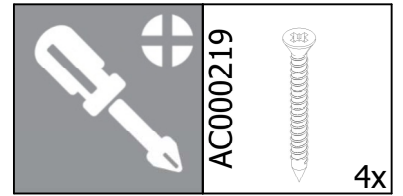

2x

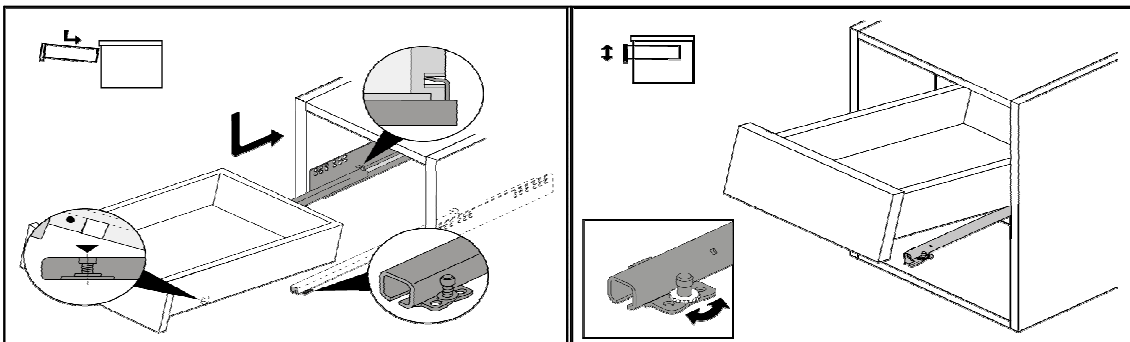
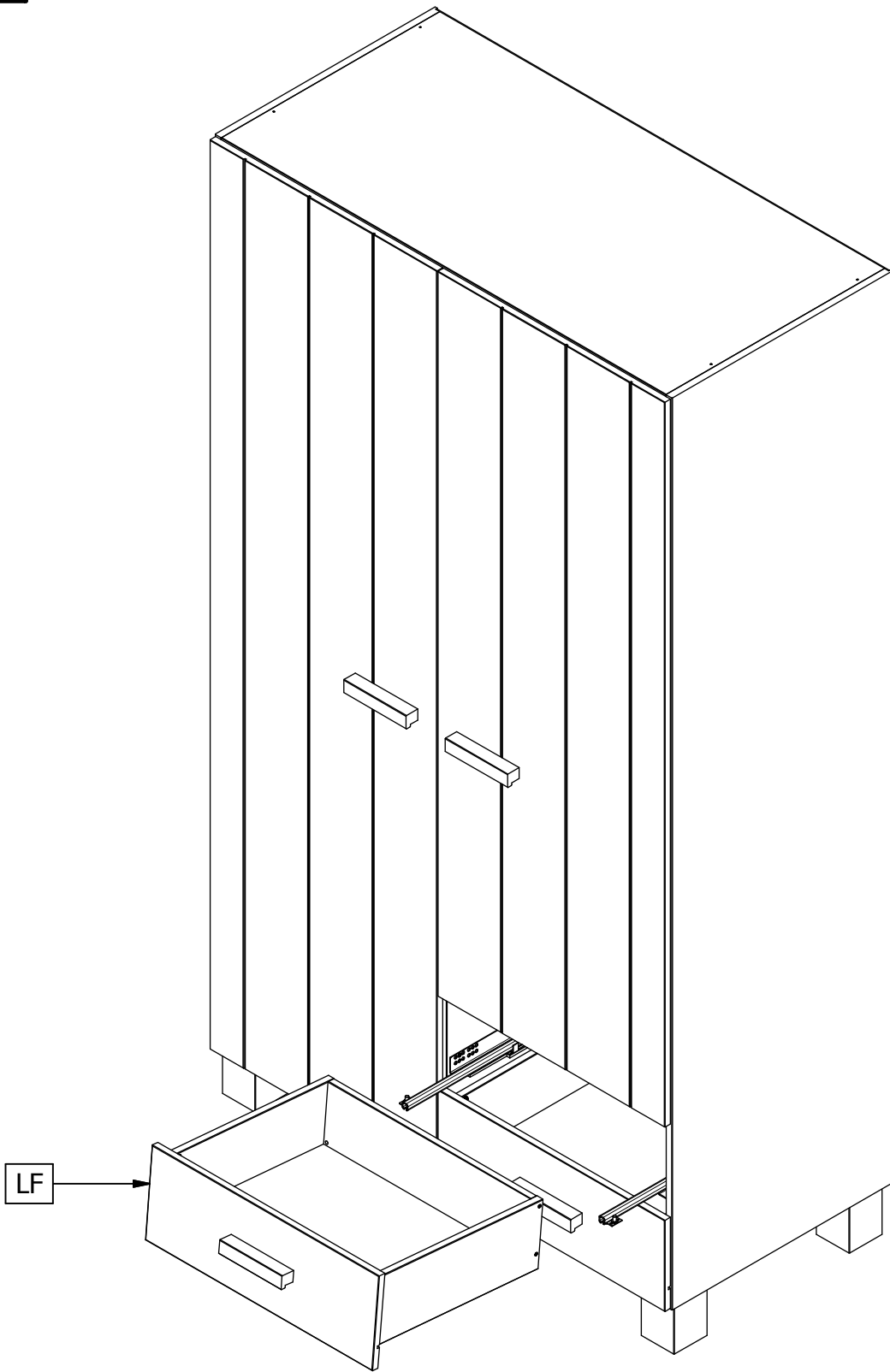

20

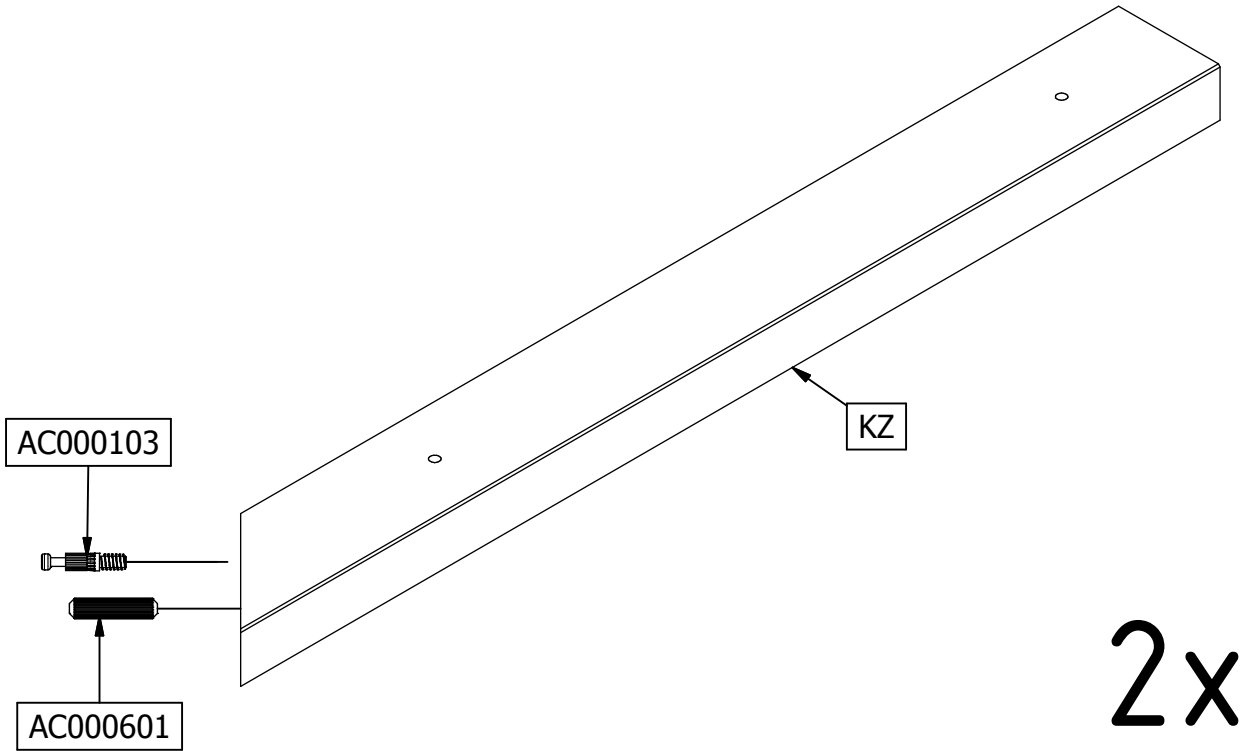
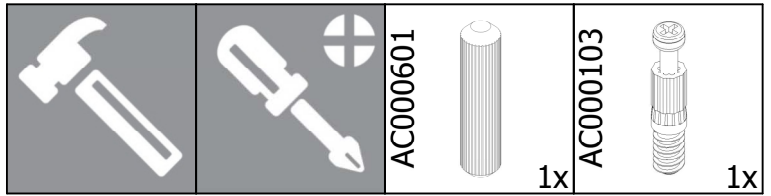

21

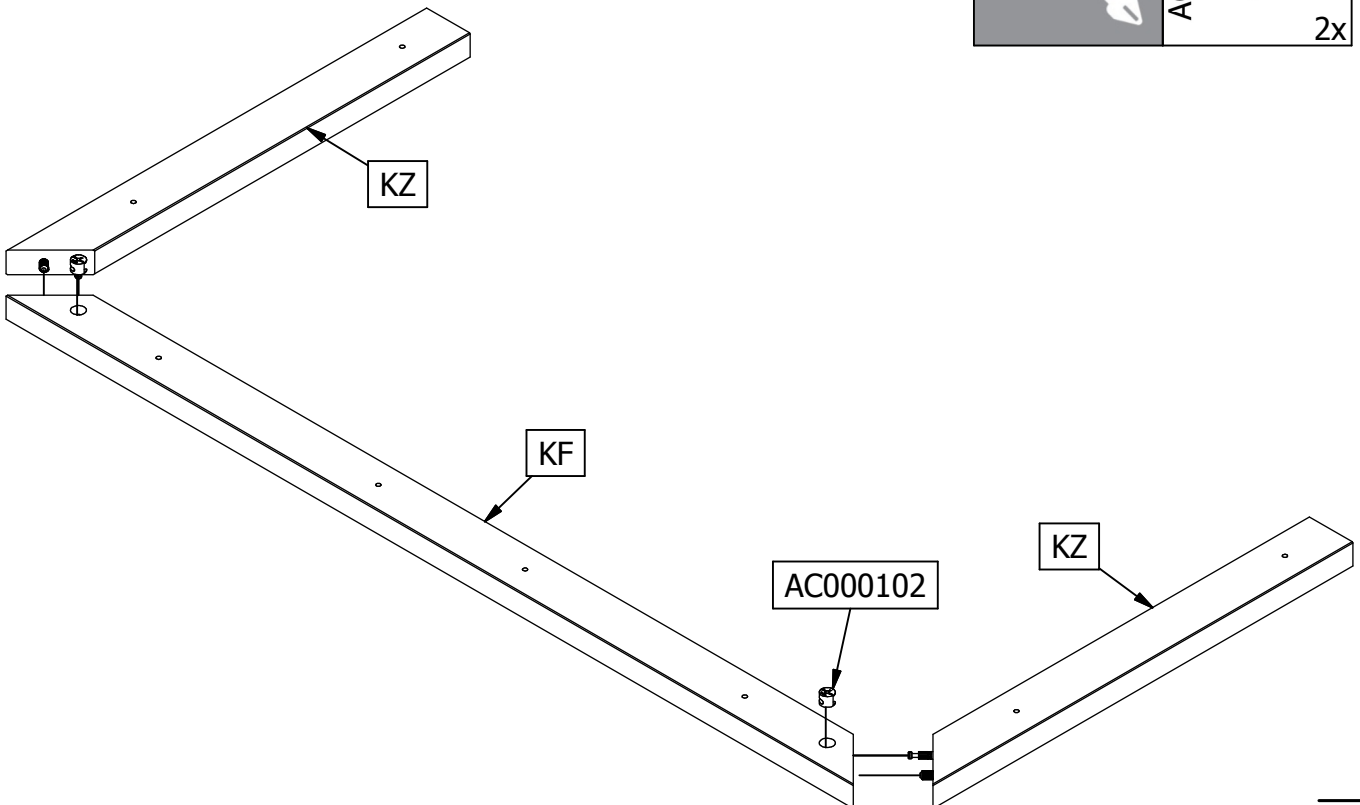
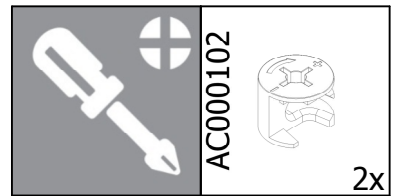

 2 PERS.		AC000203  8x
--	---	---

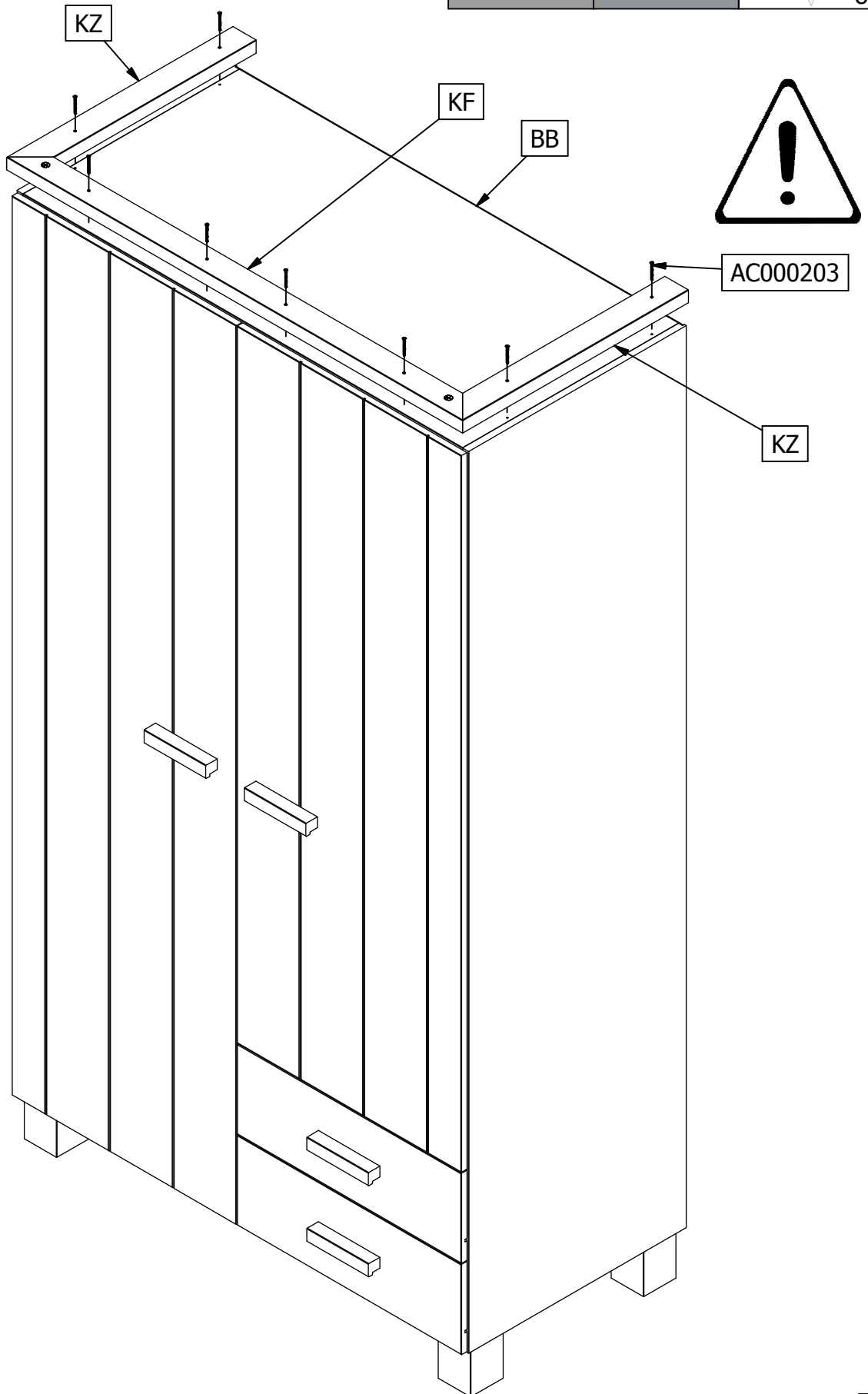

SOCIAL MEDIA

We are curious about the result! Would you like to share it with us? Use #WOOOD on social media.
Wir sind gespannt auf das Ergebnis! Möchten Sie es mit uns teilen? Benutzen Sie #WOOOD in Social Media.

Nous sommes impatient de connaître le résultat. Souhaitez-vous le partager avec nous? Utilisez #WOOOD sur les médias sociaux.



facebook.com/wood.nl
instagram.com/madebywood
pinterest.com/madebywood